

Bringing quality light
to urban contexts
with modular solutions
inspired by nature.

CELLS

Designed by SPEIRS MAJOR

Reggiani

Reggiani

Contents

Intro	04
Cells	19



Garden Conservatory, Seoul



EN Designed by SPEIRS MAJOR and inspired by the cellular eye structure of a dragonfly, CELLS is an urban lighting solution designed to be installed as single or connected multiple modules.

IT Progettato dallo studio SPEIRS MAJOR e ispirato alla struttura oculare cellulare di una libellula, CELLS è una soluzione di illuminazione urbana progettata per essere installata a moduli singoli o in cluster.

SPEIRS MAJOR

^{EN} SPEIRS MAJOR is an independent, award-winning international lighting design practice. Over more than twenty-five years, SPEIRS MAJOR has completed hundreds of projects around the world ranging from lighting masterplans to pocket parks, major civic buildings to small community spaces; from airports and bridges to cathedrals and monuments. Through careful collaboration between a multidisciplinary design team, clients and design partners, SPEIRS MAJOR ensure that solutions are sustainable and easy to manage, balancing imagination with realism, passion with pragmatism.

^{IT} SPEIRS MAJOR è uno studio di lighting design indipendente e pluripremiato a livello internazionale. In oltre venticinque anni, SPEIRS MAJOR ha completato centinaia di progetti in tutto il mondo, spaziando da piani regolatori per l'illuminazione a piccoli parchi, da grandi edifici civici a piccoli spazi comunitari; da aeroporti e ponti a cattedrali e monumenti. Attraverso una collaborazione attenta tra un team di progettazione multidisciplinare, clienti e partner di progetto, SPEIRS MAJOR garantisce soluzioni sostenibili e facili da gestire, bilanciando immaginazione con realismo, passione con pragmatismo.





EN "CELLS' advanced control optics give you a wide choice of functionality, from general illumination to bespoke configurations, making it ideal for both architectural and technical applications, indoors and out. The modules can be mounted on ceilings and walls, and you can choose from a wide range of finishes for different locations. We envisage our CELLS bringing light to an array of urban contexts, including exterior pathways, private and public facilities, parking lots and buildings." SPEIRS MAJOR

IT "L'ampia scelta di ottiche avanzate offre grande flessibilità funzionale: da un'illuminazione generale a configurazioni su misura e rende CELLS un prodotto ideale per applicazioni sia architettoniche che tecniche, sia interne che esterne. I moduli possono essere montati a soffitto e a parete, e si può scegliere tra una vasta gamma di finiture per diverse ambientazioni. Immaginiamo i nostri CELLS portare luce in una varietà di contesti urbani, tra cui percorsi esterni, strutture private e pubbliche, parcheggi ed edifici." SPEIRS MAJOR







ELLI, Residential Building and Studio, Zurigo





^{EN} IK10 shock resistant diffuser
^{IT} Diffusore resistente ai colpi (IK10)



Google Atelier Numérique, Saint-Étienne



ELLI Residential Building and Studio, Zurigo



Garden Conservatory, Seoul



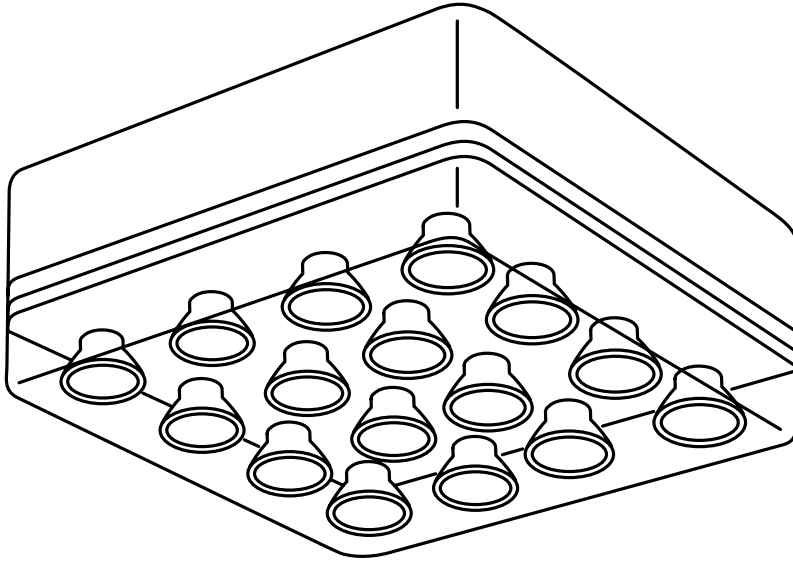











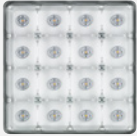

Cells

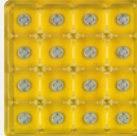

EN A range of exterior luminaires IP66 and IK10 suitable for installation in ceilings or walls. These high performance luminaires blend in perfectly with the architectural context thanks to the many aesthetic options available. The advanced optics control system makes it possible to select options for general lighting or bespoke configurations and applications.

IT Una gamma di apparecchi da esterni IP66 and IK10 per l'installazione a soffitto o a parete, in grado di fornire performance eccellenti e di integrarsi perfettamente nel contesto architettonico grazie alle diverse variabili estetiche. L'avanzato sistema di controllo del fascio consente di scegliere tra soluzioni per l'illuminazione generale o specifiche applicazioni.



Versions/ Versioni	
Cells	<div style="display: flex; justify-content: space-around; align-items: center;"> <div style="text-align: center;">  <p>Transparent</p> </div> <div style="text-align: center;">  <p>Opal</p> </div> </div>
Finishes/ Finiture	<p>Body</p> <div style="display: flex; justify-content: space-around; align-items: center;"> <div style="text-align: center;">  <p>Q/48 White/ Bianco</p> </div> <div style="text-align: center;">  <p>R/08 Graphite/ Grafite</p> </div> <div style="text-align: center;">  <p>S/28 Gray/ Grigio</p> </div> <div style="text-align: center;">  <p>V/98 Raw aluminium/ Alluminio grezzo</p> </div> </div> <p>Plates</p> <div style="display: flex; justify-content: space-around; align-items: center;"> <div style="text-align: center;">  <p>0 White/ Bianco</p> </div> <div style="text-align: center;">  <p>1 Chrome/ Cromatico</p> </div> <div style="text-align: center;">  <p>2 Gray/ Grigio</p> </div> <div style="text-align: center;">  <p>8 Graphite/ Grafite</p> </div> </div> <p>Colored plates (on request)</p> <div style="display: flex; justify-content: space-around; align-items: center;"> <div style="text-align: center;">  <p>Yellow/ Giallo</p> </div> <div style="text-align: center;">  <p>Red/ Rosso</p> </div> <div style="text-align: center;">  <p>Blue/ Blu</p> </div> <div style="text-align: center;">  <p>Green/ Verde</p> </div> </div>
Color temperature	3000 K, Tunable White (on request)
IP	66
IK	10
Control systems	On/Off, DALI, Emergency, Bluetooth (on request)
Certifications	  

Choose the diffuser

Choose the optics

Choose the plate

Choose the body

Choose your Cells

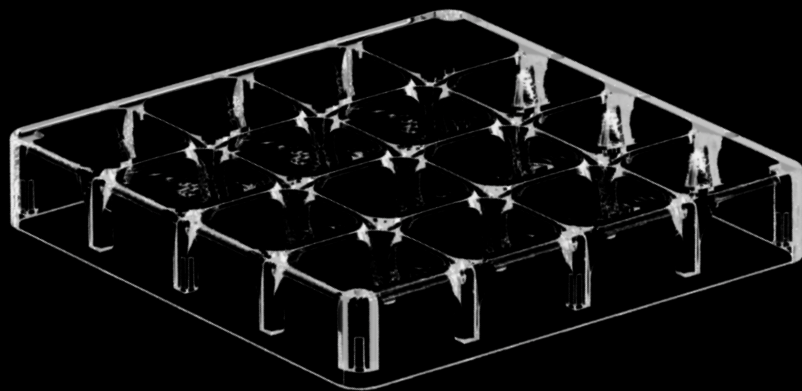

IK 10 Diffuser

- Transparent/Trasparente
- Opal/Opale



Optics

- E Medium/Medio
- M Wide/Largo
- O Very wide/Molto largo
- U Rectangular/Rettangolare
- S Asymmetric/Asimetrico
- T Double asymmetric/Doppio asimmetrico

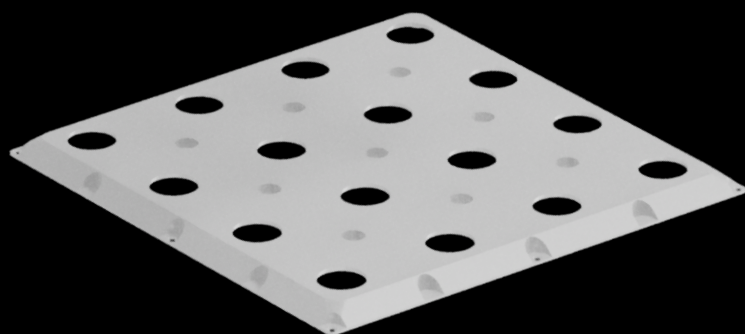

Plates

- 0 White/Bianco
- 1 Chrome/Cromato
- 2 Grey/Grigio
- 8 Graphite/Grafite

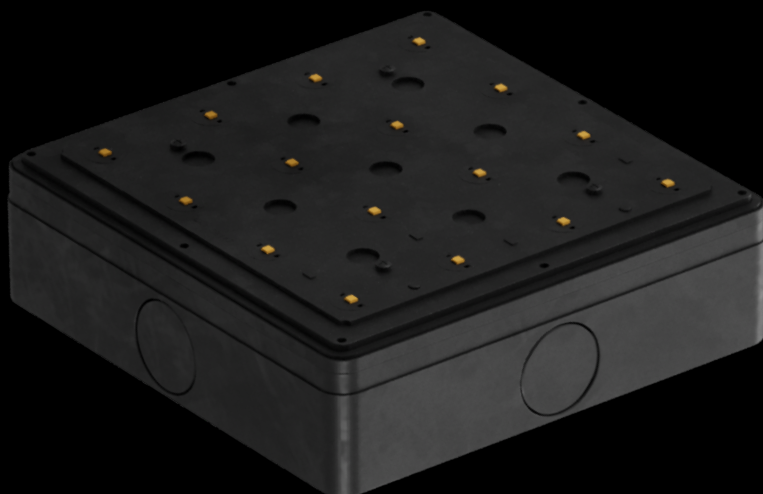

Body

- Q/48 White/Bianco
- R/08 Graphite/Grafite
- S/28 Grey/Grigio
- V/98 Raw aluminium/Alluminio grezzo

Transparent diffuser

EN Choose the transparent diffuser to get the most from all the CELLS optics alternatives: medium, wide, very wide, rectangular, asymmetric and double asymmetric. Customize the product choosing between bodies and plates.

IT Scegli il diffusore trasparente e sfrutta al meglio tutte le alternative ottiche disponibili per CELLS: medio, largo, molto largo, rettangolare, asimmetrico e doppio asimmetrico. Personalizza poi il prodotto scegliendo tra diversi i body e plates.



Body



EN White
IT Bianco



EN Raw aluminium
IT Alluminio grezzo



EN Grey
IT Grigio



EN Graphite
IT Grafite

Plates



EN White
IT Bianco



EN Chrome
IT Cromatico



EN Grey
IT Grigio

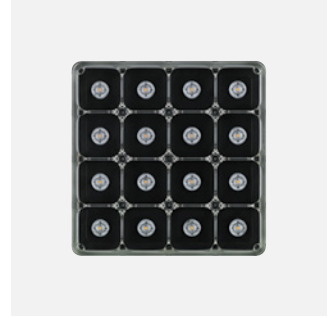

EN Graphite
IT Grafite

Optics



EN Medium
IT Medio



EN Wide
IT Largo



EN Very wide
IT Molto largo



EN Rectangular
IT Rettangolare



EN Asymmetric
IT Asimetrico



EN Double asymmetric
IT Doppio asimmetrico



Reggiani L&B booth

Examples

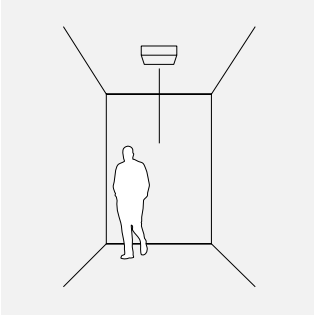

EN Optics: Medium, wide.
IT Ottica: Medio, largo.

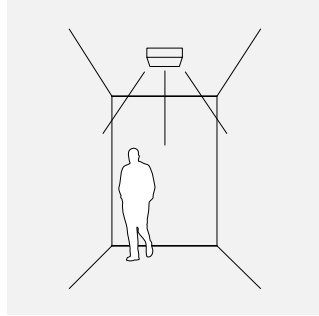

EN Optics: Rectangular or very wide.
IT Ottica: Rettangolare o molto largo.

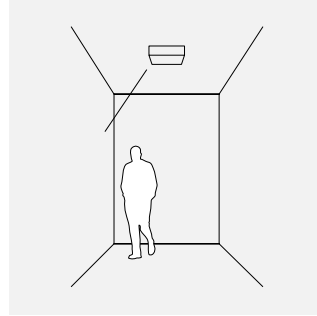

EN Optics: Asymmetric
IT Ottica: Asimmetrico.

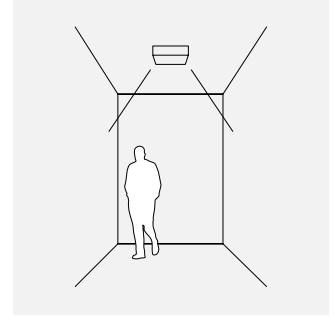

EN Optics: Double asymmetric.
IT Ottica: Doppio asimmetrico.

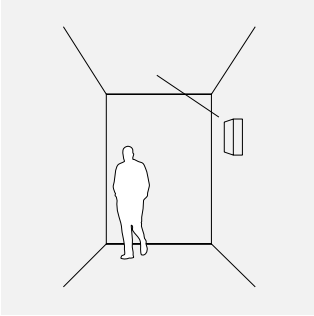

EN Optics: Asymmetric.
IT Ottica: Asimmetrico.

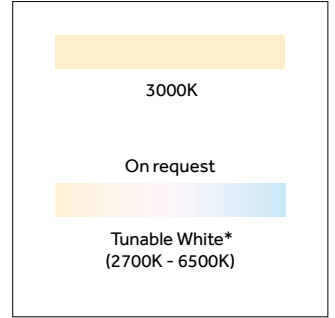

EN *For wide and very wide beam.
IT * Per fascio largo e molto largo.

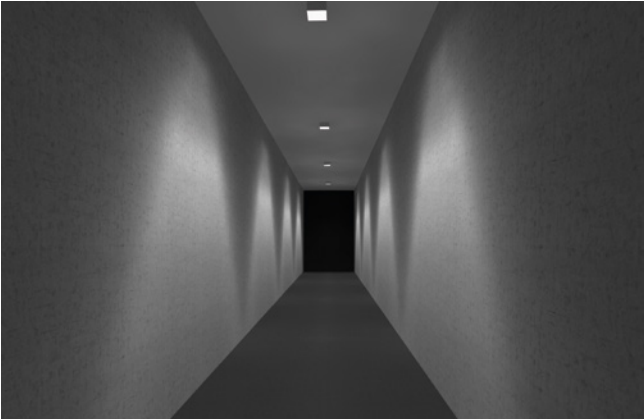

EN Optics: Double asymmetric
IT Ottica: Doppio asimmetrico



EN Optics: Rectangular or very wide.
IT Ottica: Rettangolare o molto largo.

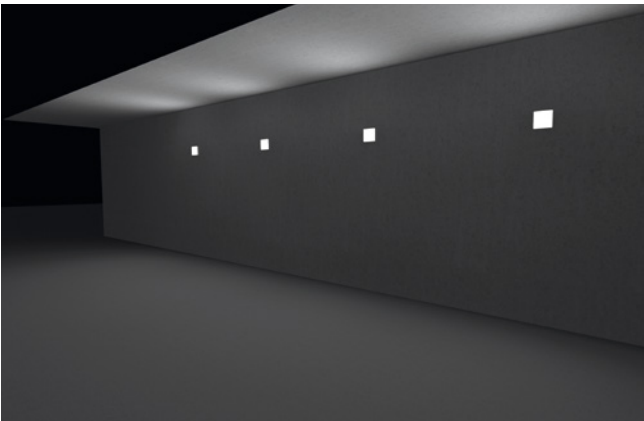

EN Optics: Asymmetric.
IT Ottica: Asimmetrico.

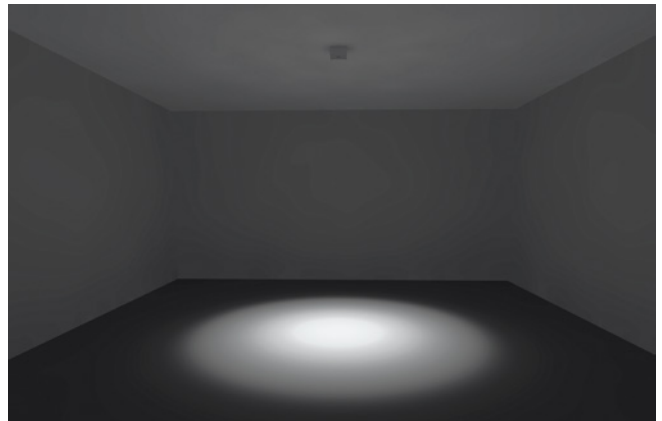

EN Optics: Medium, wide.
IT Ottica: Medio, Largo.

Opal diffuser

EN Choose the opal diffuser for a very wide and diffusive lighting effect and customize the product choosing between four different bodies.

IT Scegli il diffusore opale per un effetto di luce diffusa a fascio molto largo. Personalizza il prodotto scegliendo tra quattro diversi body.



Body



EN White
IT Bianco



EN Raw aluminium
IT Alluminio grezzo



EN Grey
IT Grigio



EN Graphite
IT Grafite

Plate



EN White
IT Bianco

Optics



EN Very wide
IT Molto largo

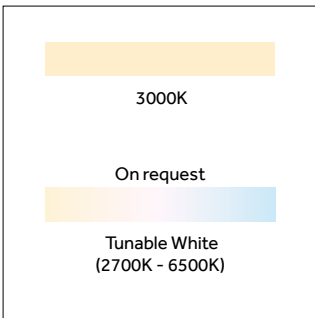

EN LED Colour temperatures
IT Temperature colore LED

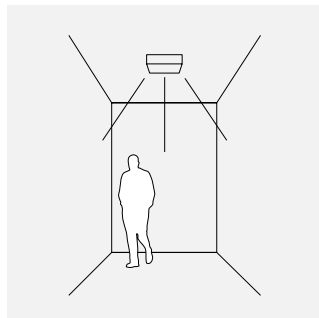

EN Optics: Very wide.
IT Ottica: Molto largo.

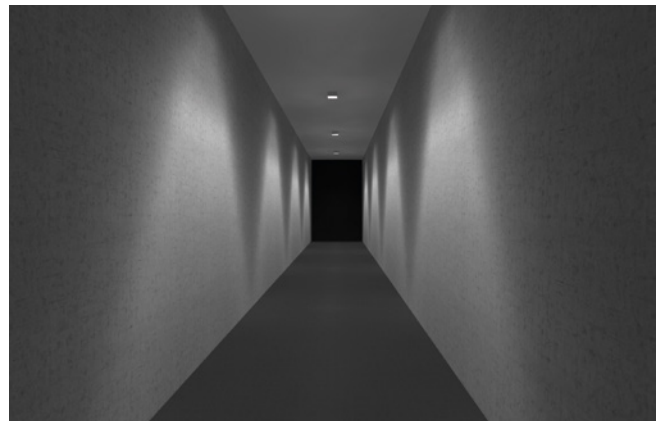

EN Optics: Rectangular or very wide.
IT Ottica: Rettangolare o molto largo.

Create your own Cells layout

EN CELLS modules can be joined together using a connector available as an accessory to create more complex lighting configurations. Anti-glare accessories and adjustable brackets further increase the flexibility of the product and its use in different environments. Create your own CELLS layout.

IT I moduli CELLS possono essere uniti tra loro tramite un connettore disponibile come accessorio per creare configurazioni di illuminazione più complesse. Gli accessori antiabbagliamento e le staffe orientabili aumentano ulteriormente la flessibilità del prodotto e le sue possibilità di utilizzo in diversi ambienti. Dai forma al tuo layout CELLS.



EN Connector
IT Connettore

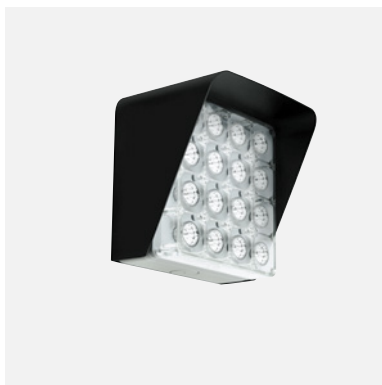

EN Visor
IT Visiera

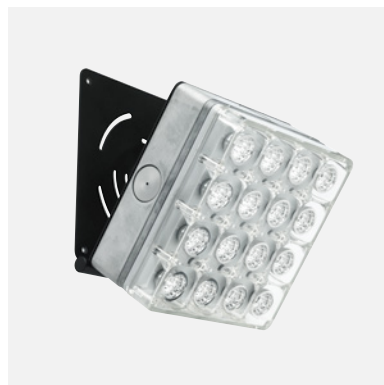

EN 90° adjustable bracket
IT Staffa per orientamento 90°





Colored plates

On request

Cells

EN On request, CELLS is also available with colored plates. The warmth of yellow, the energy of red, the tranquility of blue, or the freshness of green: combine these colors to create your personalized CELLS.

IT Su richiesta, CELLS è disponibile anche con plate colorate. Il calore del giallo, l'energia del rosso, la tranquillità del blu o la freschezza del verde: abbinare questi colori per creare i tuoi CELLS personalizzati.

Colored plates

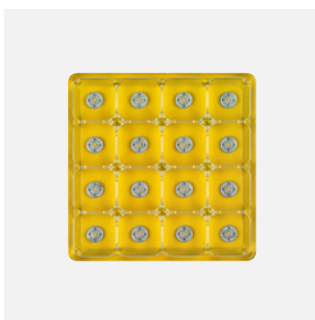

EN Yellow
IT Giallo



EN Blue
IT Blu





EN Red
IT Rosso

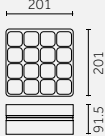
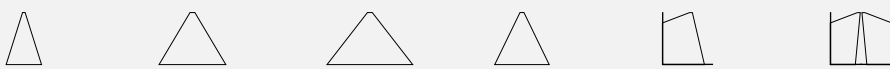

EN Green
IT Verde

Technical info & codes

Surface	 <p>p.36-37</p>																							
Beams/ Fasci	 <table border="1" data-bbox="454 705 1457 772"> <thead> <tr> <th>Medium/ Medio</th> <th>Wide/ Largo</th> <th>Very Wide/ Molto Largo</th> <th>Rectangular/ Rettangolare</th> <th>Asymmetric/ Asimmetrico</th> <th>Double Asymmetric/ Doppio Asimmetrico</th> </tr> </thead> <tbody> <tr> <td>24°</td> <td>55°</td> <td>68°</td> <td>56°+34°</td> <td>43°+61°</td> <td>86°+64°</td> </tr> <tr> <td>-</td> <td>-</td> <td>81°</td> <td>-</td> <td>-</td> <td>-</td> </tr> </tbody> </table>						Medium/ Medio	Wide/ Largo	Very Wide/ Molto Largo	Rectangular/ Rettangolare	Asymmetric/ Asimmetrico	Double Asymmetric/ Doppio Asimmetrico	24°	55°	68°	56°+34°	43°+61°	86°+64°	-	-	81°	-	-	-
Medium/ Medio	Wide/ Largo	Very Wide/ Molto Largo	Rectangular/ Rettangolare	Asymmetric/ Asimmetrico	Double Asymmetric/ Doppio Asimmetrico																			
24°	55°	68°	56°+34°	43°+61°	86°+64°																			
-	-	81°	-	-	-																			
 <p>Transparent diffuser Opal diffuser</p>	24° -	55° -	68° 81°	56°+34° -	43°+61° -	86°+64° -																		
Light source/ Sorgente luminosa	<p>LEDARRAY 13 W; 18 W 2096 lm-2560 lm L70 B50=50,000h 3000K CRI >80 SDCM <3</p> <p>Emergency 3h LEDARRAY 13 W; 18 W 2096 lm-2560 lm L70 B50=50,000h 3000K CRI >80 SDCM <3</p> <p>On request:  Tunable white 2700 K-6500K</p>																							

Transparent diffuser/Diffusore trasparente

Risk 0 2.10 IK10 IP66 850°

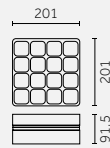

Code example:

0 . BG03 E . WW Q 0

ACCESSORIES: p.38

Notes:

Version 13W: for environments up to 50 °C/

Versione 13 W: per ambienti fino a 50 °C.

** 3 hours emergency - When operating in emergency mode, luminous flux is 30% of the lumens emitted under normal operating conditions/

**Versione emergenza 3 ore - Il prodotto in funzionamento di emergenza emette il 30% del flusso emesso in condizioni standard.

Photometric data:

www.reggiani.net

13 W LED ARRAY Lumen delivered up to 1474 lm / Lumen maintenance: L70 B50=50,000h

Driver	Version	Optics	LED K	CRI	lm	SDCM	Body	Plates
0 On/Off	BG03	E 24° Medium*	WW 3000	>80	2096	<3	Q	0
D DALI		M 55° Wide*						R 1
On request		0 68° Verywide*	LED nominal lumen				S	2
H Bluetooth		U 56°+34° Rectangular	* Tunable white: (2700K-6500K) on request				V	8
		S 43°+61° Asymmetric						
		T 86°+64° Double asymmetric						

13 W Emergency LED ARRAY** Lumen delivered up to 1474 lm / Lumen maintenance: L70 B50=50,000h

Driver	Version	Optics	LED K	CRI	lm	SDCM	Body	Plates
0 On/Off	MG03	E 24° Medium*	WW 3000	>80	2096	<3	Q	0
D DALI		M 55° Wide*						R 1
On request		0 68° Verywide*	LED nominal lumen				S	2
H Bluetooth		U 56°+34° Rectangular	* Tunable white: (2700K-6500K) on request				V	8
		S 43°+61° Asymmetric						
		T 86°+64° Double asymmetric						

18 W LED ARRAY Lumen delivered up to 1800 lm / Lumen maintenance: L70 B50=50,000h

Driver	Version	Optics	LED K	CRI	lm	SDCM	Body	Plates
0 On/Off	BG04	E 24° Medium*	WW 3000	>80	2560	<3	Q	0
D DALI		M 55° Wide*						R 1
On request		0 68° Verywide*	LED nominal lumen				S	2
H Bluetooth		U 56°+34° Rectangular	* Tunable white: (2700K-6500K) on request				V	8
		S 43°+61° Asymmetric						
		T 86°+64° Double asymmetric						

18 W Emergency* LED ARRAY Lumen delivered up to 1800 lm / Lumen maintenance: L70 B50=50,000h

Driver	Version	Optics	LED K	CRI	lm	SDCM	Body	Plates
0 On/Off	MG04	E 24° Medium*	WW 3000	>80	2560	<3	Q	0
D DALI		M 55° Wide*						R 1
On request		0 68° Verywide*	LED nominal lumen				S	2
H Bluetooth		U 56°+34° Rectangular	* Tunable white: (2700K-6500K) on request				V	8
		S 43°+61° Asymmetric						
		T 86°+64° Double asymmetric						

Finishes / Finiture

Body	Plates
○ Q White/Bianco	○ 0 White/Bianco
● R Graphite/Grafite	● 1 Chrome/Cromato
● S Grey/Grigio	● 2 Grey/Grigio
○ V Raw aluminium/Alluminio grezzo	● 8 Graphite/Grafite

Opal diffuser/Diffusore Opale

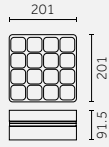

Code example:

0 . **CG03** . **0** . **WW** **48**

ACCESSORIES: p.38

Notes:

Version 13W: for environments up to 50 °C/
Versione 13 W: per ambienti fino a 50 °C.

* 3 hours emergency - When operating in emergency mode, luminous flux is 30% of the lumens emitted under normal operating conditions/
*Versione emergenza 3 ore - Il prodotto in funzionamento di emergenza emette il 30% del flusso emesso in condizioni standard,

Photometric data:
www.reggiani.net

13 W LED ARRAY Lumen delivered up to 1015 lm / Lumen maintenance: L70 B50=50,000h

Driver	Version	Optics	LED	K	CRI	lm	SDCM	Body	Plates
0 On/Off	CG03	0 81° Very wide	WW	3000	>80	2096	<3	48	White plate only
D DALI								08	
On request								28	
H Bluetooth								98	

LED nominal lumen
Tunable white: (2700K-6500K) on request

13 W Emergency* LED ARRAY Lumen delivered up to 1015 lm / Lumen maintenance: L70 B50=50,000h

Driver	Version	Optics	LED	K	CRI	lm	SDCM	Body	Plates
0 On/Off	NG03	0 81° Very wide	WW	3000	>80	2096	<3	48	White plate only
D DALI								08	
								28	
								98	

LED nominal lumen

18 W LED ARRAY Lumen delivered up to 1240 lm / Lumen maintenance: L70 B50=50,000h

Driver	Version	Optics	LED	K	CRI	lm	SDCM	Body	Plates
0 On/Off	CG04	0 81° Very wide	WW	3000	>80	2560	<3	48	White plate only
D DALI								08	
On request								28	
H Bluetooth								98	

LED nominal lumen
Tunable white: (2700K-6500K) on request

18 W Emergency* LED ARRAY Lumen delivered up to 1240 lm / Lumen maintenance: L70 B50=50,000h

Driver	Version	Optics	LED	K	CRI	lm	SDCM	Body	Plates
0 On/Off	NG04	0 81° Very wide	WW	3000	>80	2560	<3	48	White plate only
D DALI								08	
								28	
								98	

LED nominal lumen

Finishes / Finiture

Body

- 48** White/Bianco
- 08** Graphite/Grafite
- 28** Grey/Grigio
- 98** Raw aluminium/Alluminio grezzo

Accessories

Mounting accessories/ Accessori montaggio

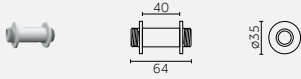

Description

Connector/
Connettore

Code

0.26030.00

Finishes

48
08
28
98

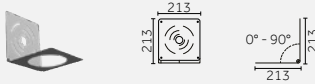

Description

90° adjustable bracket/
Staffa per orientamento 90°

Code

0.26111.00

Finishes

48
08
28
00

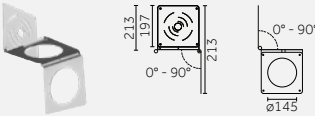

Description

90° two axis adjustable bracket/
Staffa per doppio orientamento 90°

Code

0.26112.00

Finishes

48
08
28
00

Cells accessories/ Accessori Cells

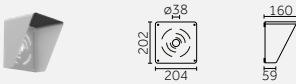

Description

Visor/
Visiera

Code

0.26110.00

Finishes

48
08
28
00

Reggiani

©
2024
Reggiani Lighting S.r.l
All rights reserved

^{EN} Reggiani Lighting Srl reserves the right to make technical, design and size changes at any time, without prior notice. Total or partial reproduction of this document is prohibited. Luminaire sizes are given in millimetres. All technical and design innovations are patented. Watts and lumens refer to the nominal values of the LED source; for photometric data and lumen output of the luminaires, visit www.reggiani.net

^{IT} Reggiani Lighting Srl si riserva la facoltà di effettuare in qualsiasi momento senza preavviso, variazioni tecniche, formali e dimensionali. Sono vietate le riproduzioni anche parziali del presente documento. Le dimensioni degli apparecchi sono espresse in millimetri. Tutte le innovazioni tecniche e formali sono coperte da brevetto. Watt e lumen fanno riferimento ai valori nominali della sorgente LED, per i dati fotometrici e il lumen output degli apparecchi visitare www.reggiani.net

HEADQUARTERS
Reggiani Lighting Srl

Viale Monza 16
20845 Sovico (MB), Italy
T. (+39) 039 20711
contact@reggiani.net

Art direction
Reggiani

Graphic design
Reggiani

Pictures
Rohspace (p.4, 17)
Radek Brunecky (p.12, 16)
Marco Reggi (p.13, 26, 31)
David Foessel (p. 15)

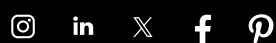

Part of
NEMO Group

