

One line, endless possibilities.

A miniaturized yet high performing, integrated track lighting solution.

INCLINE 48V

Reggiani

Reggiani

Contents

Overview	22
Incline Opal	27
Incline Dark Performance (UGR<19)	43
Incline Dark Performance (UGR<15)	63
Incline Dark Performance Adjustable	73
Incline Wall Washer	83
Track 48V	105









EN Add technical linear lighting tools to the super versatile 48V track system. General lighting, task lighting, wall washing: whatever you need, there's an Incline 48V option for your projects.

IT Trasforma i binari 48V in un sistema di illuminazione lineare tecnico. Illuminazione diffusa, illuminazione d'accento, illuminazione per uffici, wall washing: qualunque sia la tua necessità, c'è una versione di Incline 48V per ogni progetto.

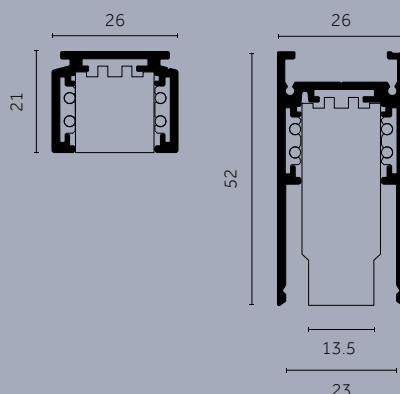

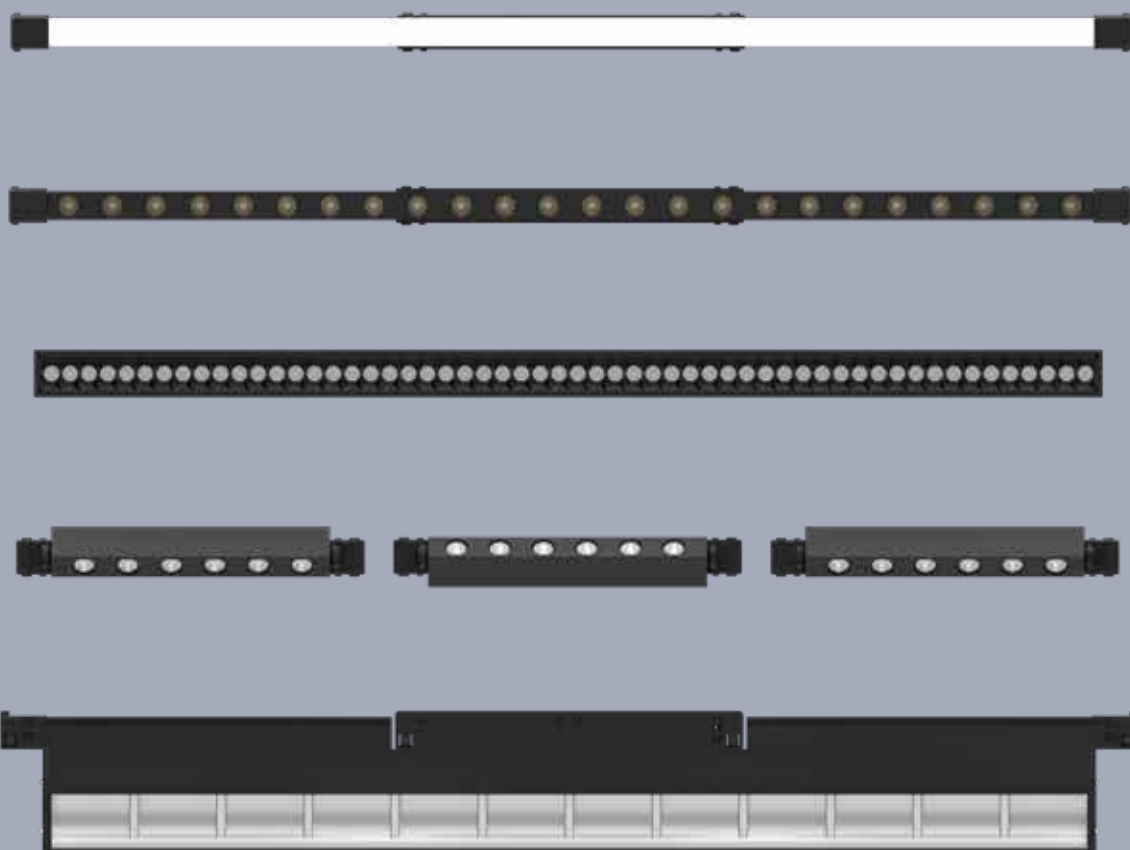

^{EN} Incline 48V is available in versions: Opal, Dark Performance (UGR<19), Dark Performance (UGR<15), Dark Performance Adjustable and Wall Washer. Asymmetric optic is available on request.

^{IT} Incline 48V è disponibile in versione: Opal, Dark Performance (UGR<19), Dark Performance (UGR<15), Dark Performance Adjustable e Wall Washer. Disponibile su richiesta anche ottica asimmetrica.



^{EN} Incline Dark Performance with UGR<19 assures no glare and therefore visual comfort in the workplace.

^{IT} Incline Dark Performance con UGR<19 assicura assenza di abbagliamento e comfort visivo in ambienti di lavoro.





^{EN} Incline 48V is available both in the standard and deep version: with the standard version, the driver is connected beside the product. With the deep version, the driver is connected beside the product.

^{IT} Incline 48V è disponibile sia in versione standard che deep: con la versione standard, il driver è collegato al prodotto e ne segue quindi la lunghezza. Con la versione deep, il driver è installato sul retro del prodotto e quindi nascosto all'interno del binario.

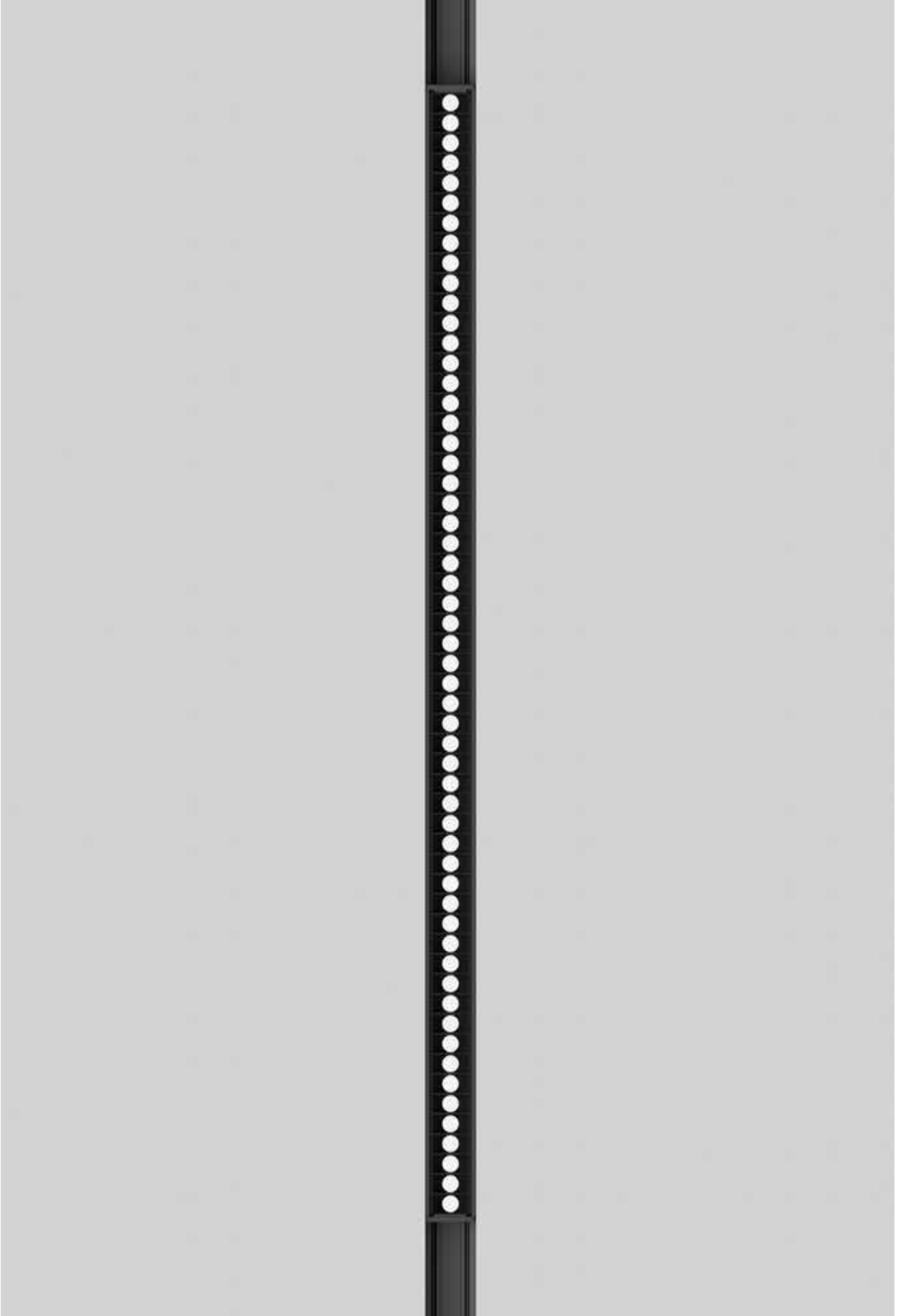



^{EN} Accent what you wish, thanks to the orientability of Incline 48V Adjustable.
^{IT} Metti in luce ciò che desideri, grazie all'orientabilità di Incline 48V Adjustable.



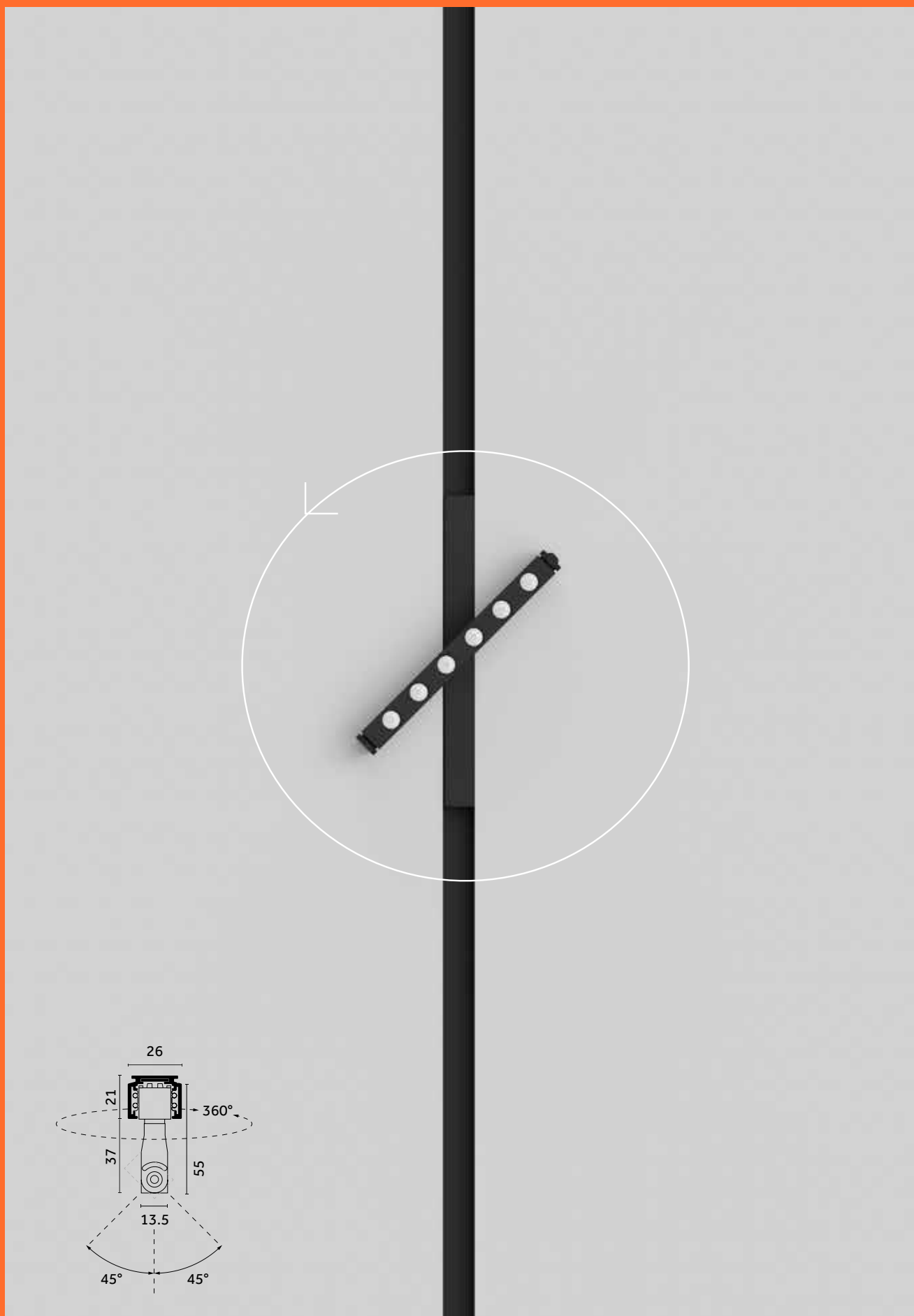

^{EN} Incline 48V Dark Performance Adjustable features a +/-45° adjustability on the vertical axis and 360° on the horizontal axis.

^{IT} La versione Adjustable di Incline 48V Dark Performance permette un'orientabilità di +45°/-45° sull'asse verticale e 360° sull'asse orizzontale.

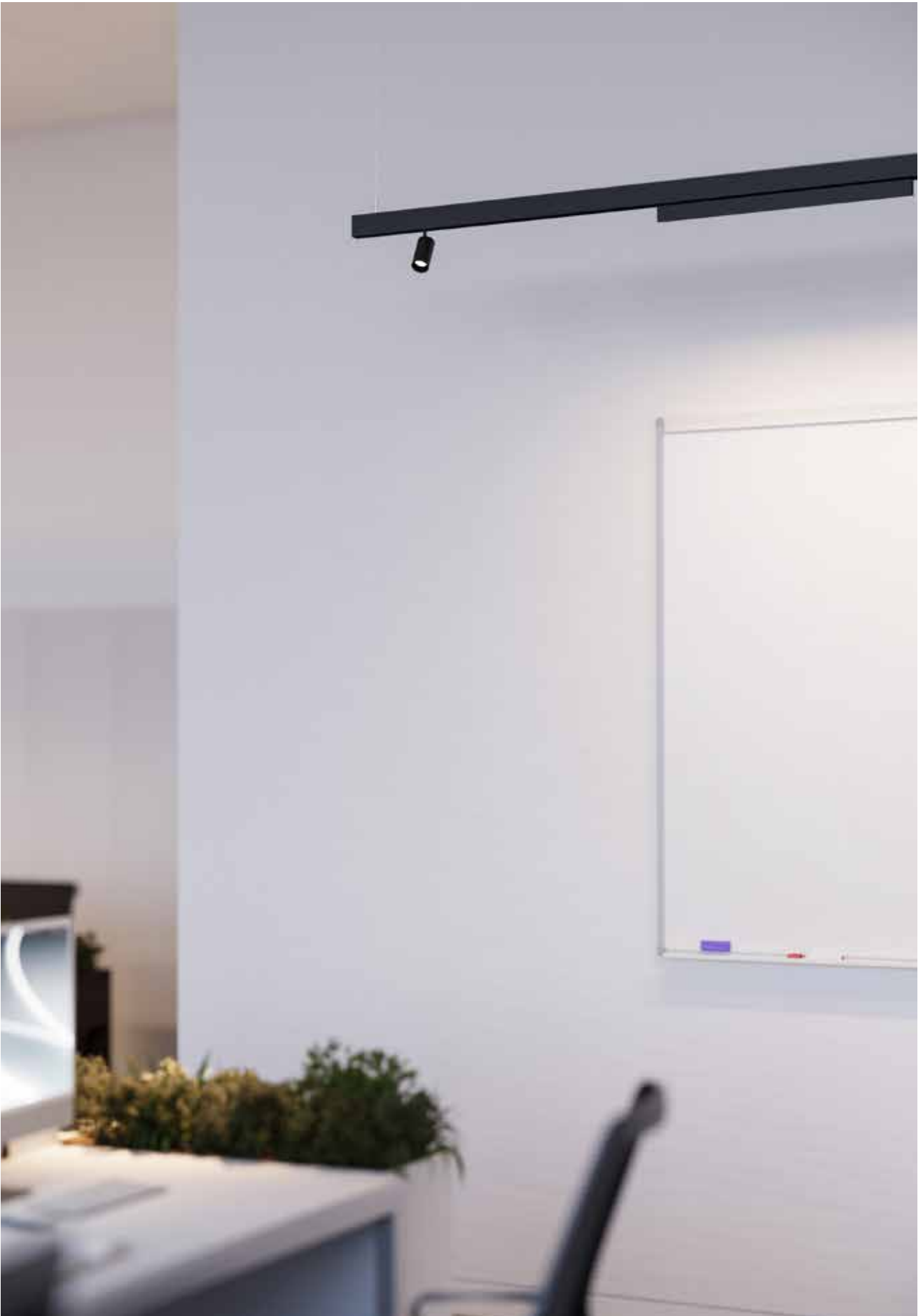

^{EN} Soft, uniform wall wash providing accent lighting to the space by using the Incline 48V Wall Washer.

^{IT} Incline 48V Wall Washer garantisce un risultato di wall wash soft ed uniforme.

Choose your 48V linear friend

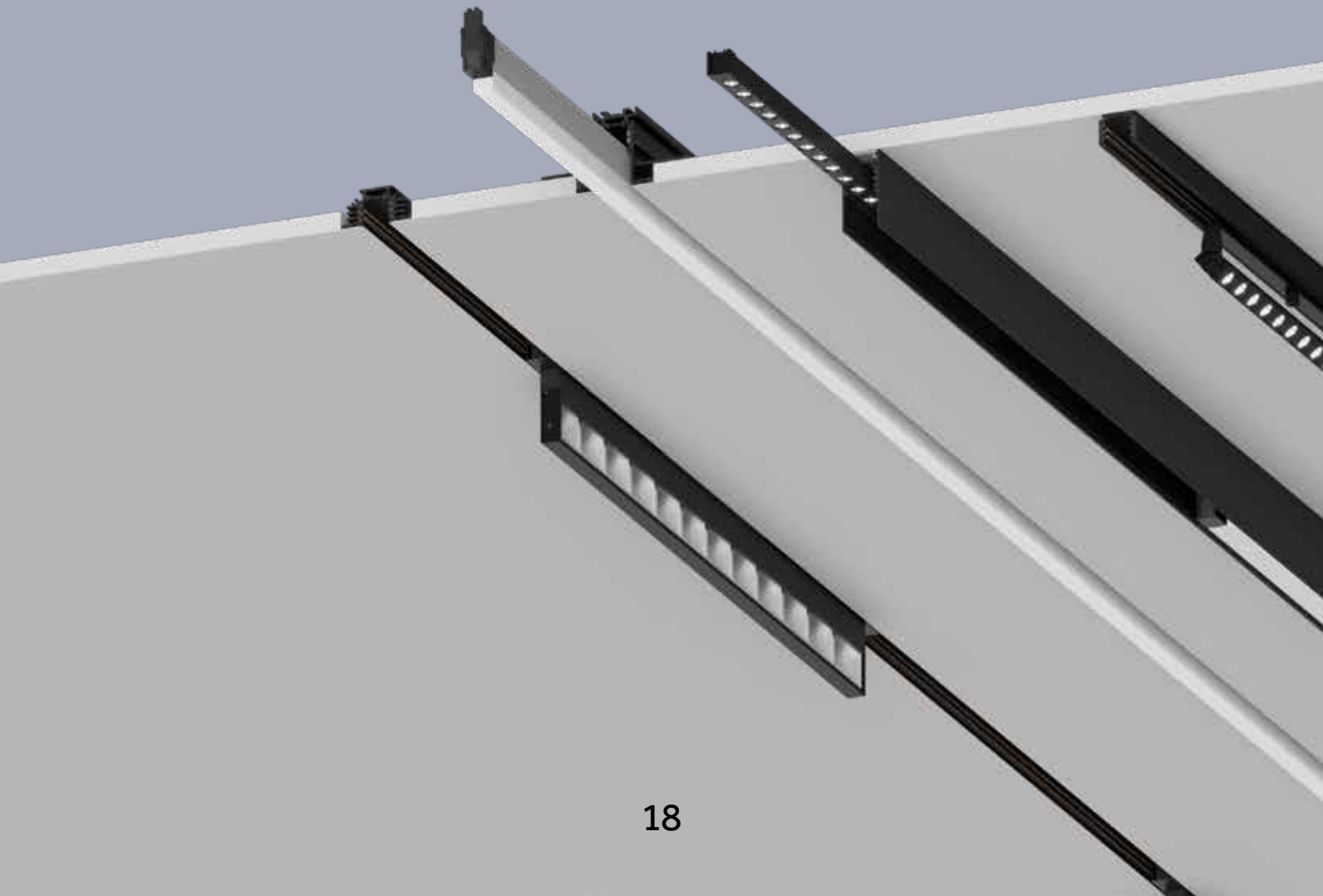



Incline 48V Opal
p.27



Incline 48V Dark Performance
(UGR<19)
p.43



Incline 48V Dark Performance
(UGR<15)
p.63



Incline 48V Dark Performance
Adjustable
p.73



Incline 48V Wall Washer
p.83

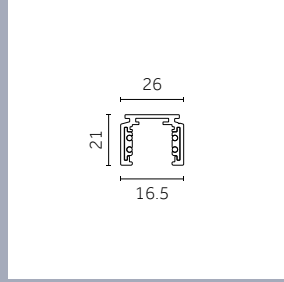

Low voltage Tracks 48V
p.105

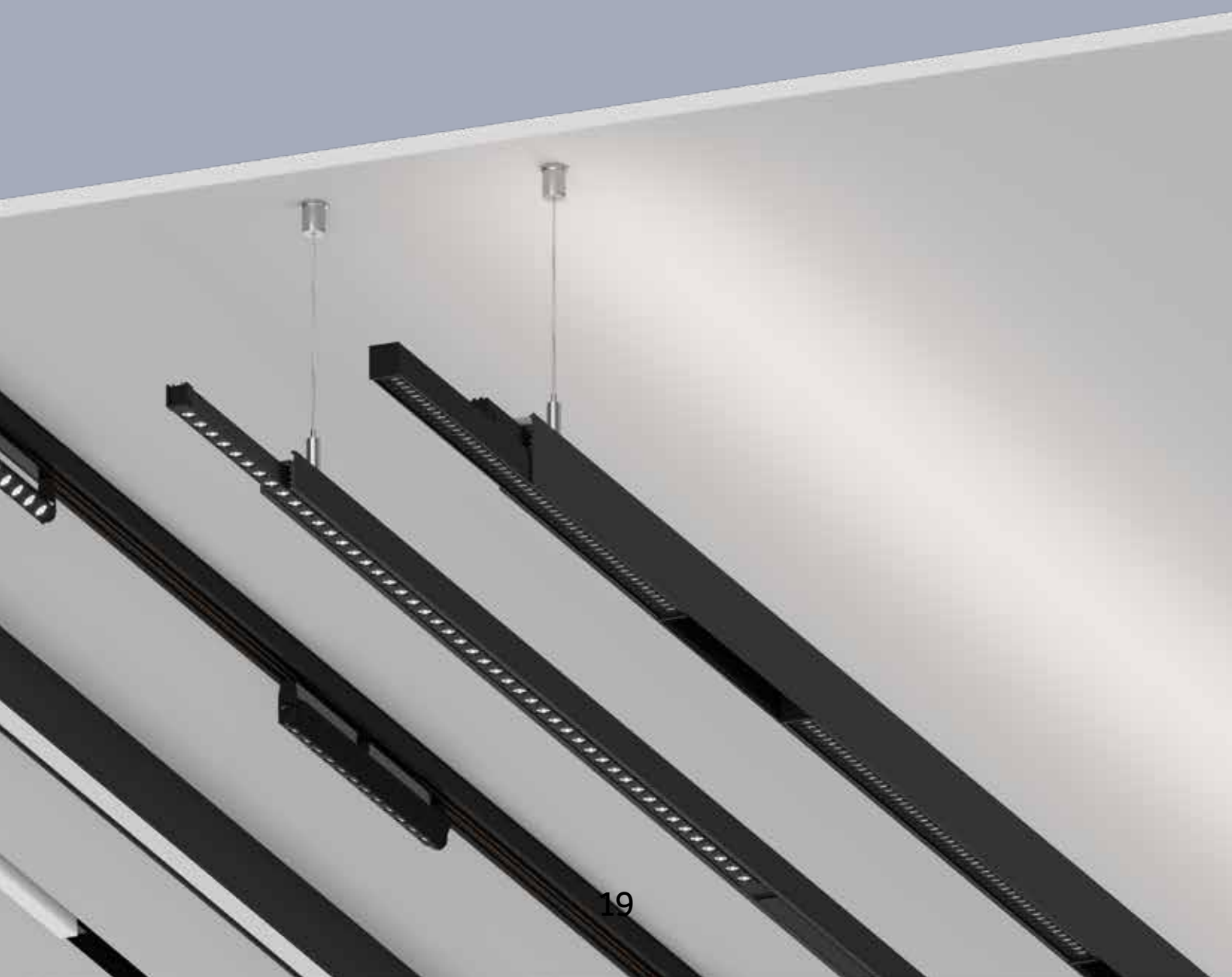

Standard version

Incline 48V Opal

Incline 48V Opal

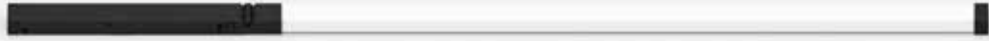

Incline 48V Dark Performance (UGR<19)

Incline 48V
Dark Performance
(UGR<19)



Incline 48V Dark Performance (UGR<15)

Incline 48V Dark Performance Adjustable

Incline 48V
Dark Performance
Adjustable



Incline 48V Wall Washer

Incline 48V
Wall Washer



Deep version

Incline 48V Opal
Deep



Incline 48V Opal
Deep (Drop)



Incline 48V
Dark Performance
(UGR<19) Deep













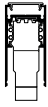

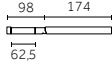
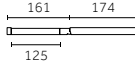



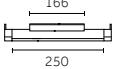

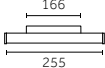

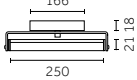

Incline 48V
Dark Performance
(UGR<15)

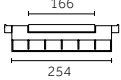

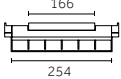
Incline 48V
Wall Washer
Deep

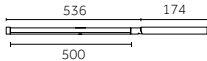
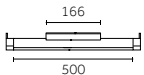
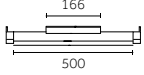
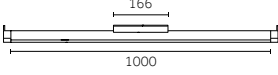
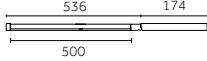
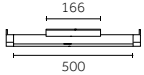
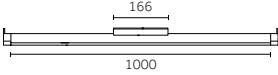
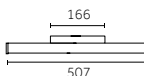
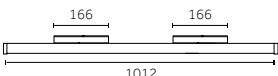

Incline 48V	Version	62,5 mm	125 mm	250 mm
 <p>Opal</p>	 Standard			
	 Deep			
	 Deep (Drop)			
 <p>Dark Performance (UGR<19)</p>	 Standard	 <p>p.56</p>	 <p>p.56</p>	 <p>p.56</p>
	 Deep	 <p>p.57</p>	 <p>p.57</p>	 <p>p.57</p>
 <p>Dark Performance (UGR<15)</p>	 Deep			 <p>p.71</p>
 <p>Dark Performance Adjustable</p>	 Standard		 <p>p.80</p>	 <p>p.80</p>
 <p>Wall Washer</p>	 Standard			 <p>p.94</p>
	 Deep			 <p>p.95</p>
 Beams		Dark Performance (UGR<19): 18°; 24°; 35°; 50°	Dark Performance (UGR<19); Dark Performance Adjustable: 18°; 24°; 35°; 50°	Dark Performance (UGR<19); Dark Performance Adjustable: 18°; 24°; 35°; 50° Dark Performance (UGR<15): 40° Wall Washer
<p>Light source/ Sorgente luminosa</p>		Dark Performance (UGR<19) 2 W 254 lm - 275 lm Dark Performance (UGR<19) Deep 2 W; 3W 254 lm - 411 lm	Dark Performance (UGR<19) 4 W 508 lm - 551 lm Dark Performance (UGR<19) Deep 4 W; 7W 508 lm - 882 lm	Dark Performance (UGR<19) 6 W 803 lm - 870 lm Dark Performance (UGR<19) Deep 8 W; 14W 1017 lm - 1764 lm
				Dark Performance (UGR<15) Deep 5 W 728 lm - 810 lm
			Dark Performance Adjustable 7 W 859 lm - 931 lm	Dark Performance Adjustable 14 W 1718 lm - 1862 lm
				Wall Washer 12 W 1642 lm - 1779 lm

500 mm	1000 mm	1500 mm
 <p>p.38</p>	 <p>p.38</p>	
 <p>p.39</p>	 <p>p.39</p>	 <p>p.39</p>
 <p>p.40</p>	 <p>p.40</p>	 <p>p.40</p>
 <p>p.56</p>	 <p>p.56</p>	
 <p>p.58</p>	 <p>p.58</p>	
 <p>p.71</p>	 <p>p.71</p>	
 <p>p.94</p>		
 <p>p.95</p>		
<p>Opal: 114°, Opal Drop: 165°/108° Dark Performance (UGR<19): 18°; 24°; 35°; 50° Dark Performance (UGR<15): 40° Wall Washer</p>	<p>Opal: 114°, Opal Drop: 165°/108° Dark Performance (UGR<19): 18°; 24°; 35°; 50° Dark Performance (UGR<15): 40°</p>	<p>Opal: 114°, Opal Drop: 165°/108°</p>
<p>Incline 48V Opal 8 W 1152 lm - 1216 lm Incline 48V Opal -Deep Incline 48V Opal -Deep (Drop) 9 W; 10 W Tunable white 1155 lm - 1684 lm; 1338 lm-1412 lm</p>	<p>Incline 48V Opal 16 W 2304 lm - 2432 lm Incline 48V Opal -Deep Incline 48V Opal -Deep (Drop) 19 W; 20 W Tunable white 3110 lm - 3368 lm; 2649 lm-2796 lm</p>	<p>Incline 48V Opal -Deep Incline 48V Opal -Deep (Drop) 28 W; 30 W Tunable white 4642 lm - 5027 lm; 3934 lm-4151 lm</p>
<p>Dark Performance (UGR<19) 11 W 1606 lm - 1740 lm Dark Performance (UGR<19) Deep 11 W; 27 W 2034 lm - 2203 lm</p>	<p>Dark Performance (UGR<19) 22 W 3212 lm - 3480 lm Dark Performance (UGR<19) Deep 22 W 4067 lm - 4406 lm</p>	
<p>Dark Performance (UGR<15) Deep 11 W 1456 lm - 1620 lm</p>	<p>Dark Performance (UGR<15) Deep 22 W 2912 lm - 3240 lm</p>	
<p>Wall Washer 24 W 3284 lm - 3558 lm</p>		





Incline Opal 48V

Incline 48V

^{EN} Incline 48V Opal is the perfect solution for ambient lighting, guaranteeing a soft, homogeneous result. Incline 48V Opal is available for both standard and deep tracks, with a flush or drop diffuser that ensures a more diffuse and aesthetic result, mitigating the "cave effect".

^{IT} Incline 48V Opal è la soluzione perfetta per luce d'ambiente, garantendo un'illuminazione soft ed omogenea. Incline 48V Opal è disponibile sia per binari standard che per binari Deep, con diffusore a filo o in versione drop che assicura un risultato più diffuso ed estetico, attenuando l'"effetto caverna".

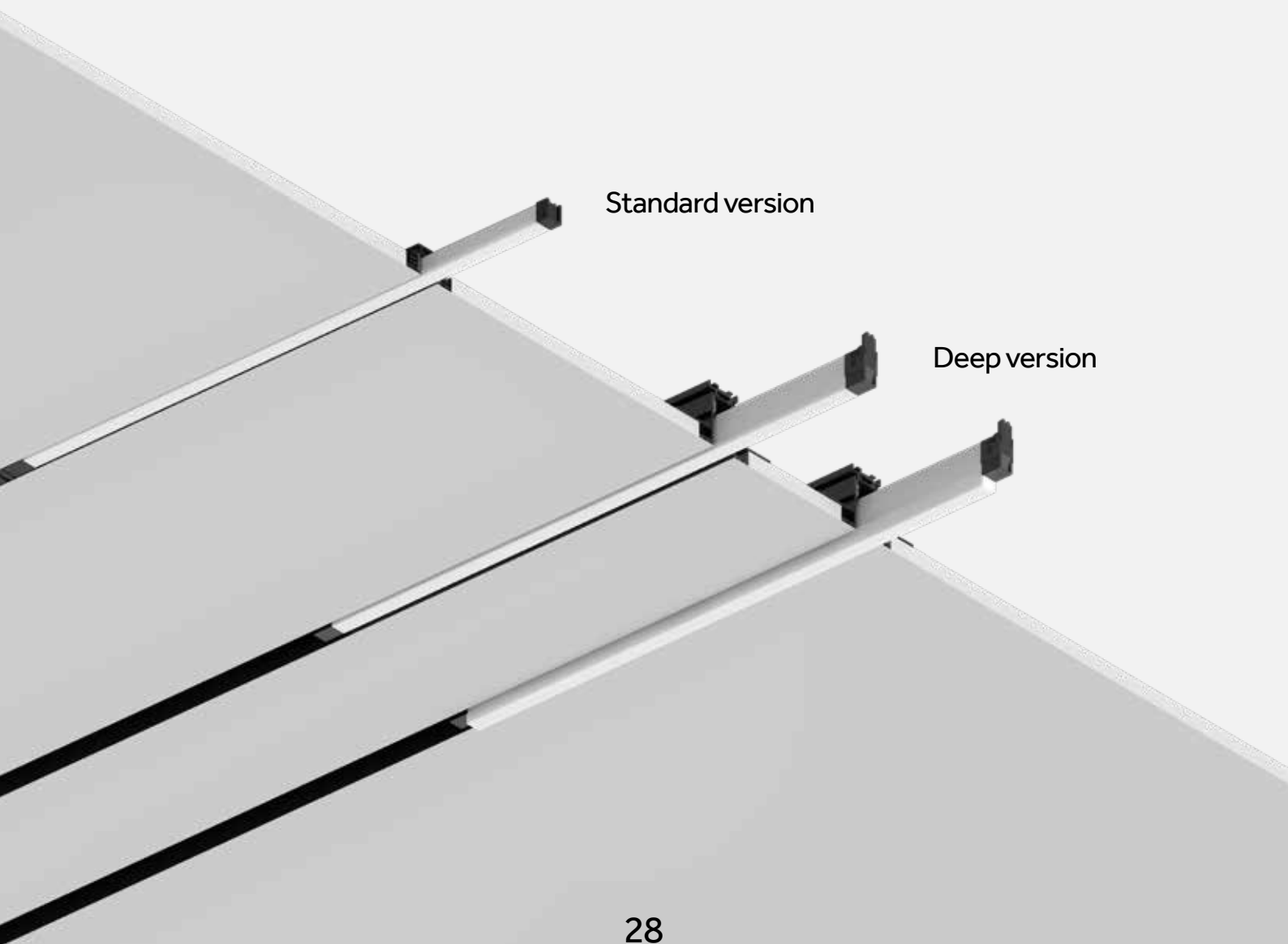

Incline 48V Opal

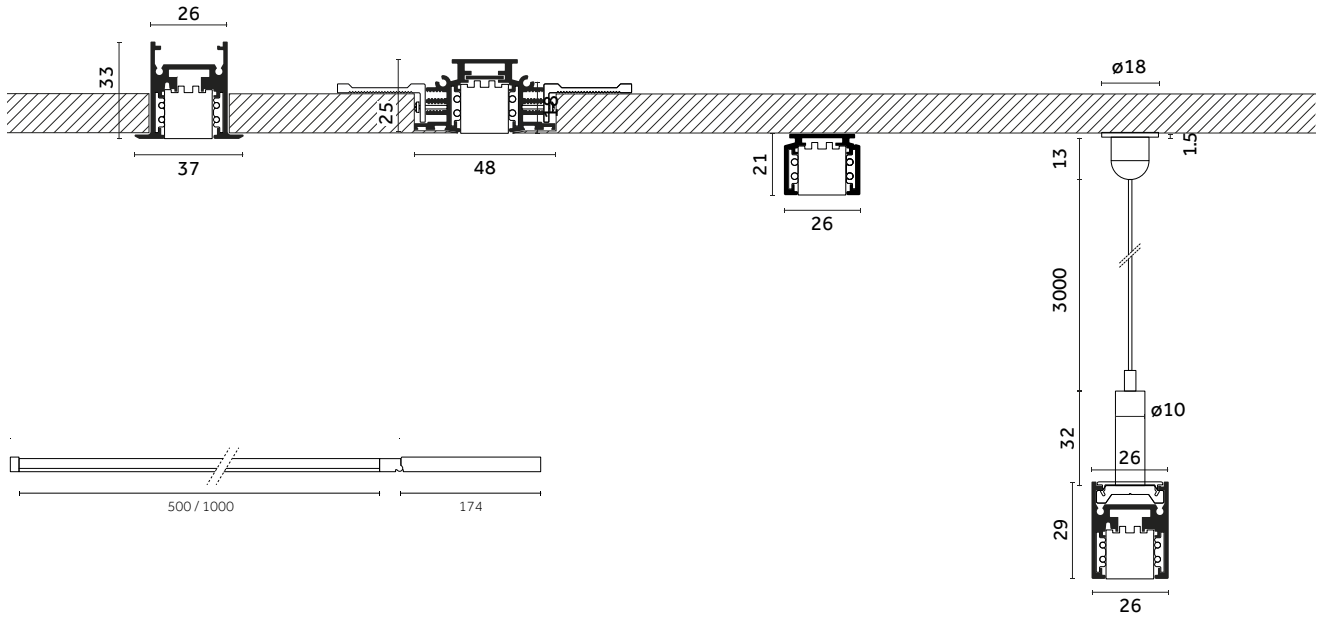

^{EN} Incline 48V Opal made for standard track, features a driver that is connected beside the product.

^{IT} Incline 48V Opal, nella sua versione per binari standard, è caratterizzato da un driver che segue la lunghezza del prodotto.

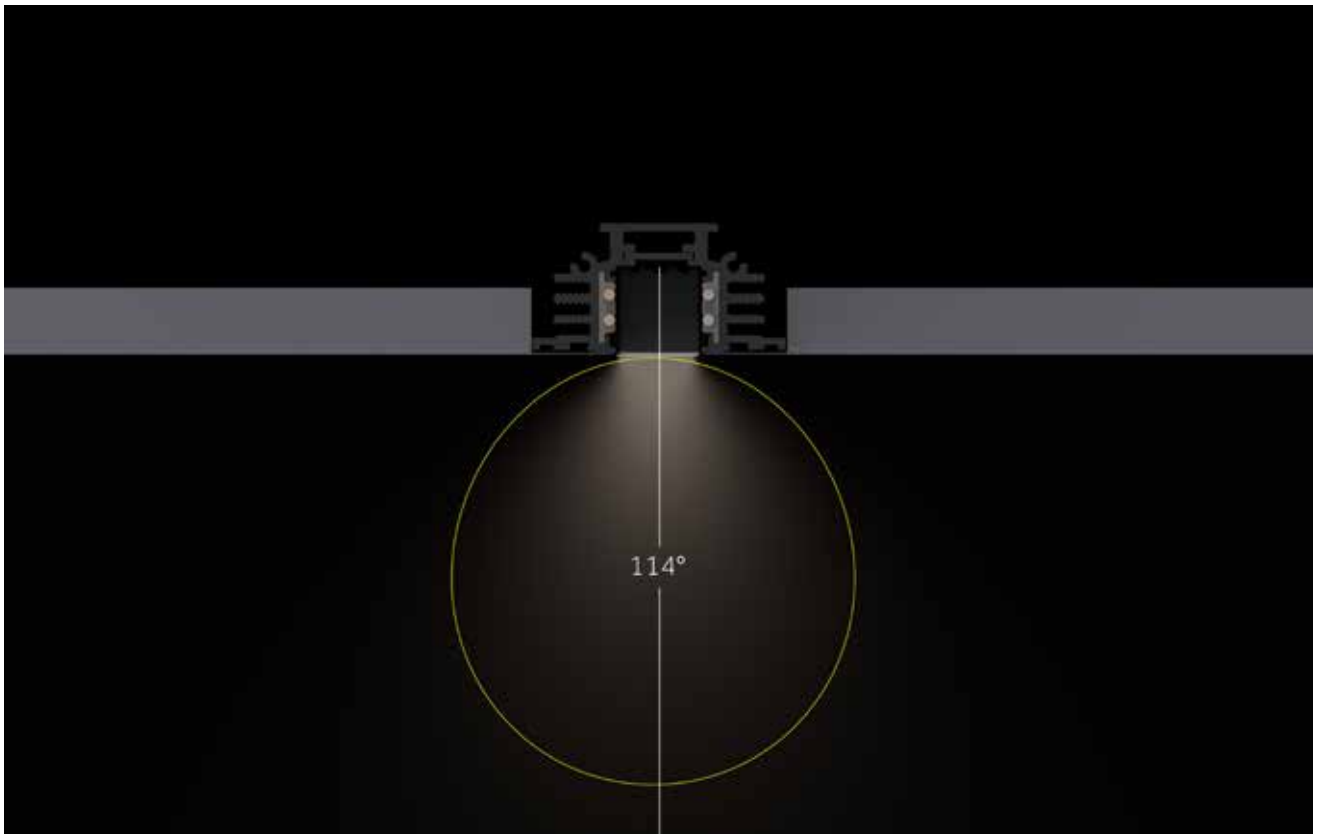

^{EN} The 114° beam angle of Incline 48V Opal guarantees a soft and uniform result.

^{IT} Il fascio di luce di 114° di Incline 48V Opal garantisce un risultato soft ed uniforme.

Incline 48V Opal - Deep

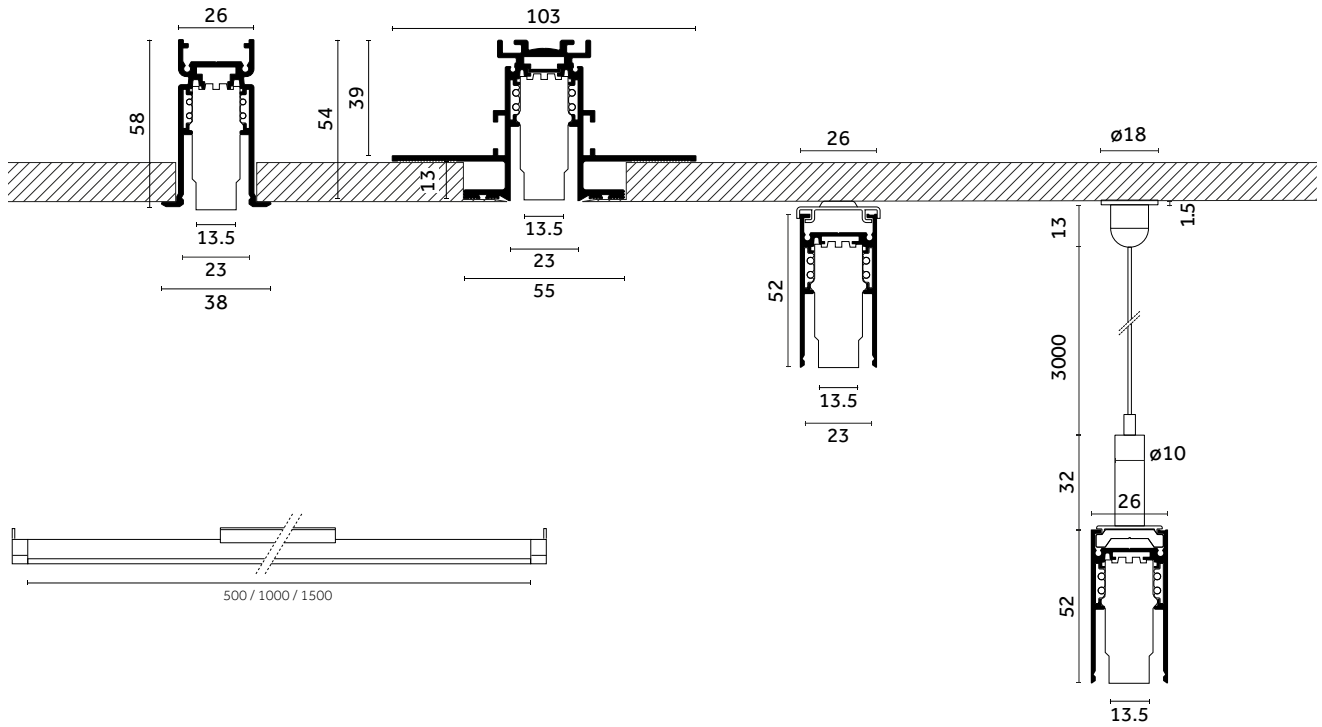

^{EN} Incline 48V Opal - Deep's concealed driver disappears inside the Deep track.
^{IT} Il driver arretrato di Incline 48V Opal - Deep scompare all'interno del binario Deep.

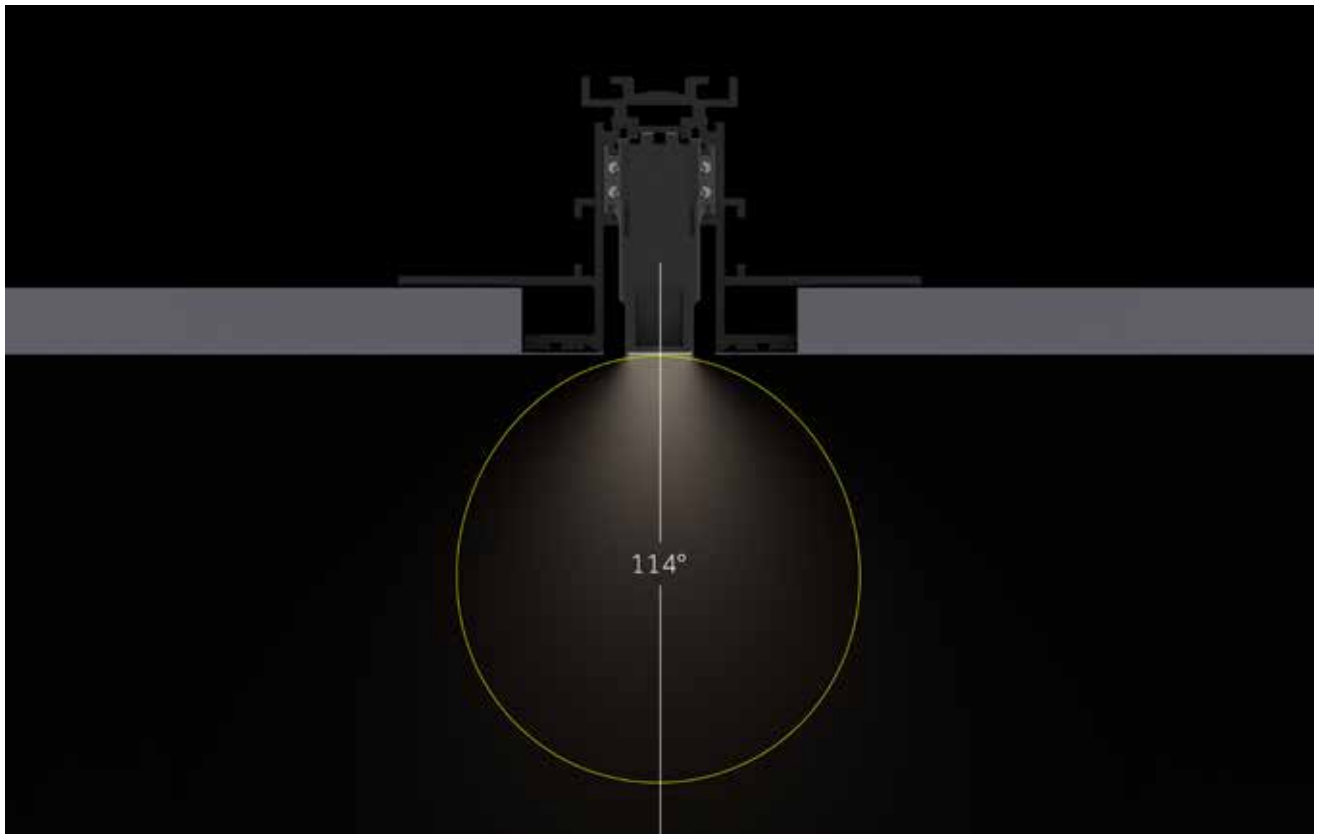

^{EN} The 114° beam angle of Incline 48V Opal - Deep guarantees a soft and uniform result.
^{IT} Il fascio di luce da 114° di Incline 48V Opal - Deep garantisce un risultato soft ed uniforme.

Incline 48V Opal - Deep (Drop)

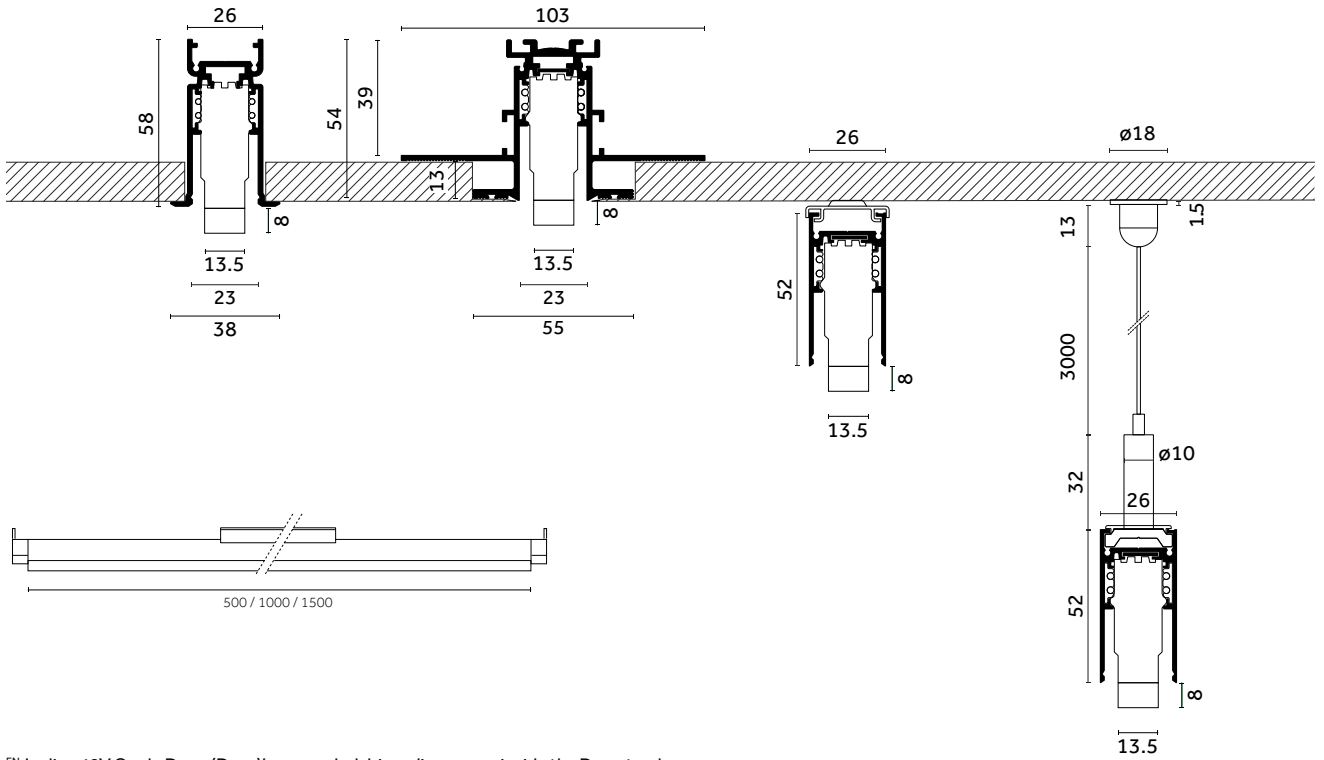

^{EN} Incline 48V Opal - Deep (Drop)'s concealed driver disappears inside the Deep track.
^{IT} Il driver arretrato di Incline 48V Opal - Deep (Drop) scompare all'interno del binario Deep.

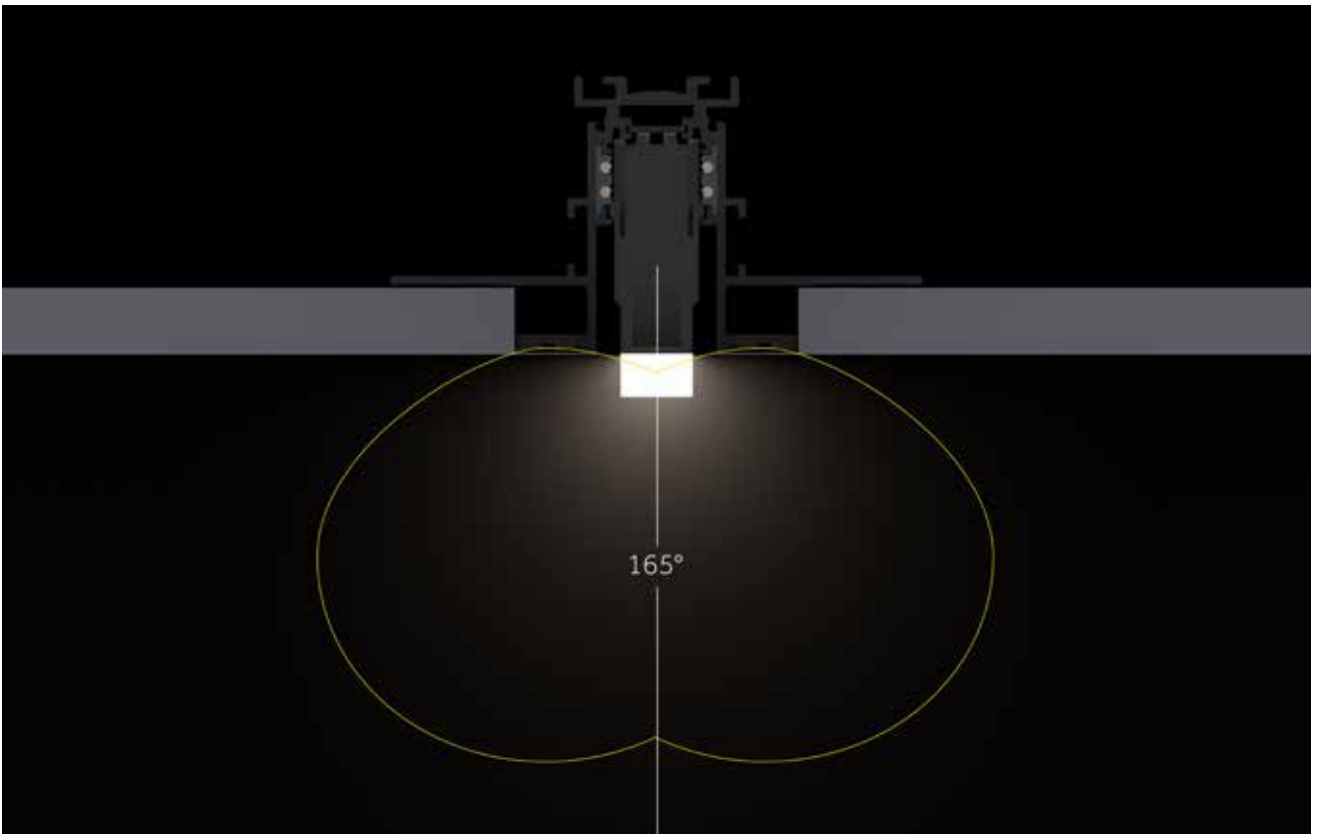

^{EN} The exposed part of Incline 48V Opal Deep (Drop) emits light with a 165° beam angle, therefore reducing the "cave effect".
^{IT} La parte esposta di Incline 48V Opal Deep (Drop) permette di avere un fascio di 165°, attenuando l'"effetto caverna".



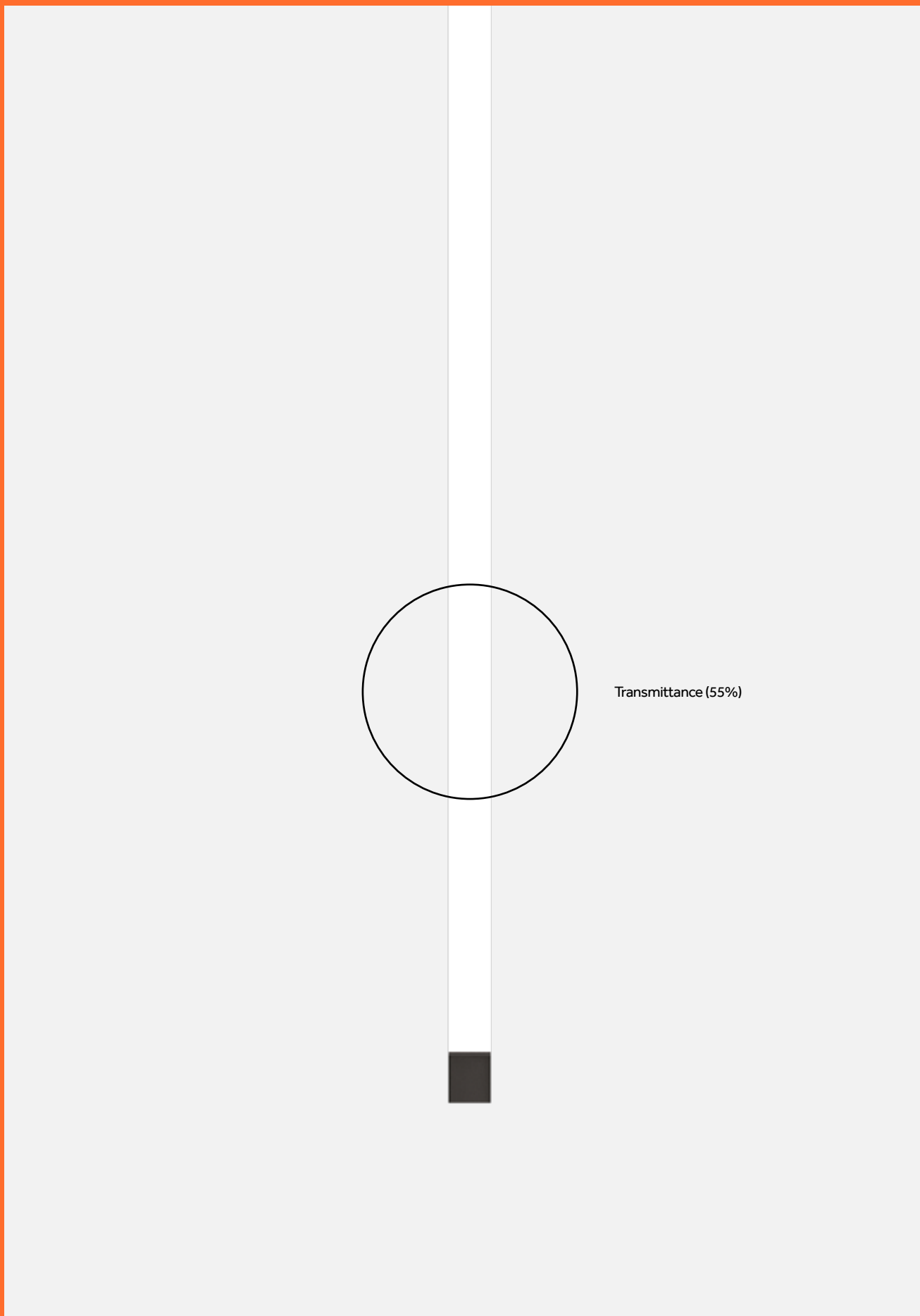

^{EN} 55% Transmittance of the opal diffuser assures no glare and light imperfections.

^{IT} La trasmittanza al 55% del diffusore opale limita l'abbagliamento e garantisce assenza di imperfezioni del risultato illuminotecnico.

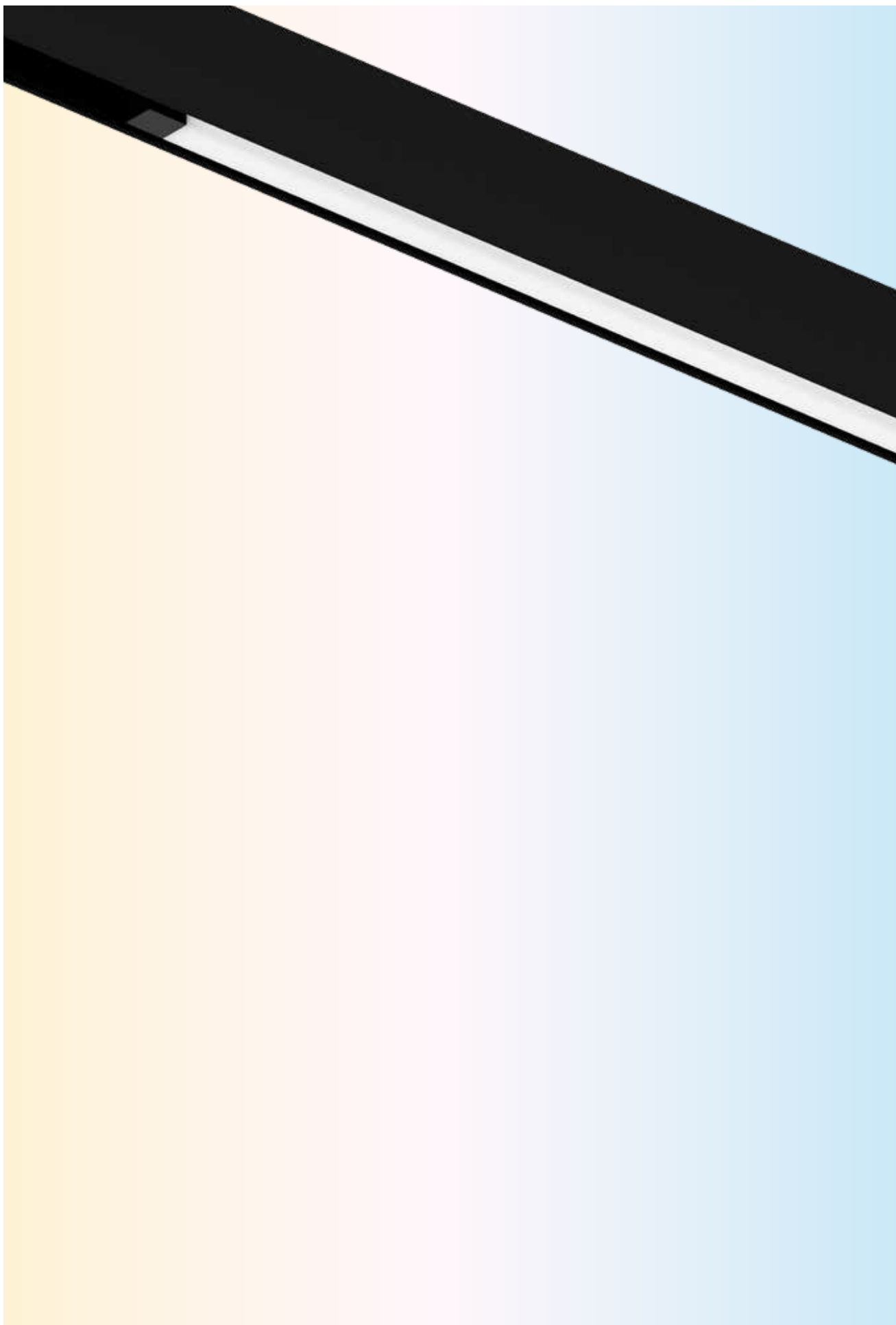

EN Incline 48V comes with LED Tunable White Technology, offering flexibility of colour temperature between 2700K and 6500K. The Warm Dimming option is available on request.

IT Incline 48V è disponibile con la tecnologia LED Tunable White, che offre una flessibilità di temperatura di colore da 2700K a 6500K. L'opzione Warm Dimming è disponibile su richiesta.



Tunable White 2700K - 6500K

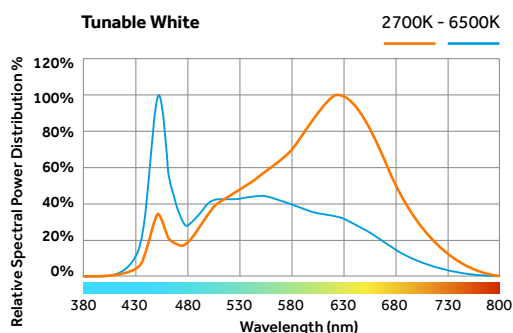

EN The spectral power distribution shows intensity of each wavelength (colour) emitted by the light source.
 IT Lo spettro della distribuzione della potenza mostra l'intensità di ciascuna lunghezza d'onda (colore) emessa dalla sorgente luminosa.



Warm Dimming (on request) 1800K - 3000K

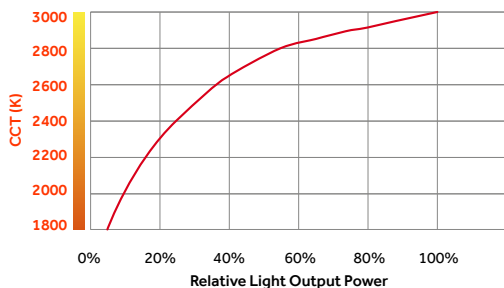



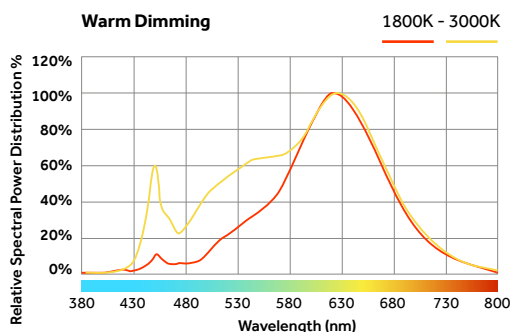



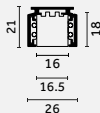
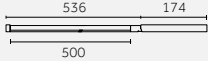
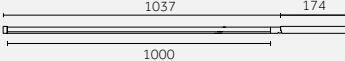
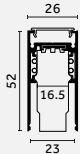
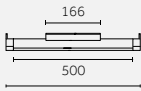
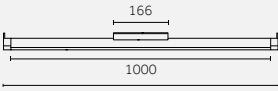
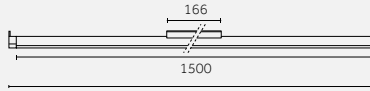
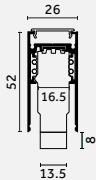
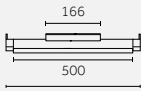
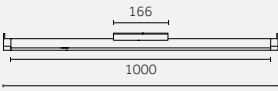
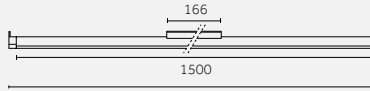

EN Colour temperature (CCT) changes according to light output levels (relative Light Output Power) dictated by the current provided to the LED (forward current). The lower the lighting level, the warmer the CCT.
 IT La temperatura colore cambia in base al livello di emissione luminosa definita dalla corrente del LED (corrente diretta). Più basso è il livello di illuminazione, più calda è la temperatura colore.



EN The spectral power distribution shows intensity of each wavelength (colour) emitted by the light source.
 IT Lo spettro della distribuzione della potenza mostra l'intensità di ciascuna lunghezza d'onda (colore) emessa dalla sorgente luminosa.

Technical info & codes

	500mm	1000mm	1500mm
<p>Incline 48V Opal</p> 			
	p.38	p.38	
<p>Incline 48V Opal Deep</p> 			
	p.39	p.39	p.39
<p>Incline 48V Opal Deep (Drop)</p> 			
	p.40	p.40	p.40
	114°	114°	114°
<p>Light source/ Sorgente luminosa</p>	<p>Incline 48V Opal STRIP COB LED 8 W 1152 lm - 1216 lm L70 B10=50,000h 2700 K, 3000 K, 3500 K CRI >90 SDCM <3 On request: (4000K, CRI >90)</p> <p>—</p>	<p>Incline 48V Opal STRIP COB LED 16 W 2304 lm - 2432 lm L70 B10=50,000h 2700 K, 3000 K, 3500 K CRI >90 SDCM <3 On request: (4000K, CRI >90)</p> <p>—</p>	
	<p>Incline 48V Opal -Deep Incline 48V Opal -Deep (Drop) MID POWER LED 9 W 1155 lm - 1684 lm L80 B10=50,000h 2700 K, 3000 K, 3500 K CRI >90 SDCM <3</p> <p> Tunable white COB LED 10 W 1338 lm - 1412 lm L80 B10=50,000h 2700 K-6500 K CRI >90 SDCM <3-<5 On request: (4000K, CRI >90)</p> <p> Warm Dimming (1800K-3000K - CRI >95)</p>	<p>Incline 48V Opal -Deep Incline 48V Opal -Deep (Drop) MID POWER LED 19 W 3110 lm - 3368 lm L80 B10=50,000h 2700 K, 3000 K, 3500 K CRI >90 SDCM <3</p> <p> Tunable white COB LED 20 W 2649 lm - 2796 lm L80 B10=50,000h 2700 K-6500 K CRI >90 SDCM <3-<5 On request: (4000K, CRI >90)</p> <p> Warm Dimming (1800K-3000K - CRI >95)</p>	<p>Incline 48V Opal -Deep Incline 48V Opal -Deep (Drop) MID POWER LED 28 W 4642 lm - 5027 lm L80 B10=50,000h 2700 K, 3000 K, 3500 K CRI >90 SDCM <3</p> <p> Tunable white COB LED 30 W 3934 lm - 4151 lm L80 B10=50,000h 2700 K-6500 K CRI >90 SDCM <3-<5 On request: (4000K, CRI >90)</p> <p> Warm Dimming (1800K-3000K - CRI >95)</p>

Opal

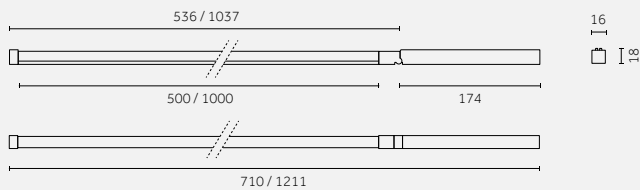
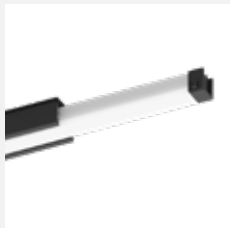

Code example:
D . **BS92** **F** . **HW** **21**

Track 48V: p. 108-109 / 112-113
 Photometric data:
www.reggiani.net

500 mm **8 W** STRIP COB LED - 19 W/m Lumen delivered up to 681 lm / Lumen maintenance: L70 B10=50,000h

Driver	Version	Length	Diffuser	Beam width	LED	K	CRI	lm	SDCM	Finishes
D DALI	BS92	500mm	F Opal55%	114°	HW	2700	>90	1152	<3	21
					HQ	3000	>90	1216	<3	
					WQ	3500	>90	1216	<3	

4000K (CRI >90) on request
 LED nominal lumen

1000 mm **16 W** STRIP COB LED - 19 W/m Lumen delivered up to 1362 lm / Lumen maintenance: L70 B10=50,000h

Driver	Version	Length	Diffuser	Beam width	LED	K	CRI	lm	SDCM	Finishes
D DALI	BS94	1000mm	F Opal55%	114°	HW	2700	>90	2304	<3	21
					HQ	3000	>90	2432	<3	
					WQ	3500	>90	2432	<3	

4000K (CRI >90) on request
 LED nominal lumen



For Track 48V
 Recessed, Surface, Surface/Pendant
 p. 108-109 / 112-113



For Traceline Track 48V
 Surface/Pendant
 Pendant Indirect
 Deep Pendant Direct / Indirect
 visit reggiani.net

Opal - Deep

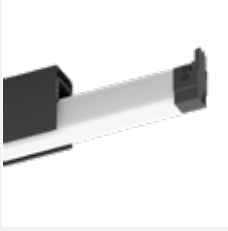

Code example:

D. **BQ92** **F.** **HW** **21**

Track 48V: p. 110-111 / 114-115
Photometric data:
www.reggiani.net

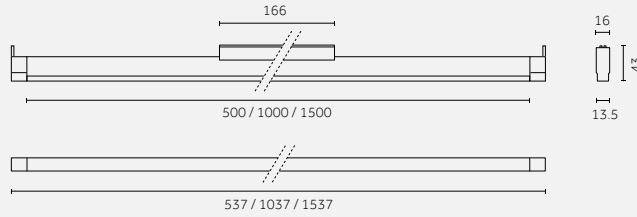

500 mm **9 W** **MID POWER LED - 19 W/m** Lumen delivered up to 690 lm / Lumen maintenance: L80 B10=50,000h

Driver	Version	Length	Diffuser	Beam width	LED	K	CRI	lm	SDCM	Finishes
D DALI	BQ92	500 mm	F Opal 55%	114°	HW	2700	>90	1555	<3	21
					HQ	3000	>90	1684	<3	
					WQ	3500	>90	1684	<3	

4000K (CRI >90) on request
 Warm Dimming 1800K-3000K (CRI >95) on request
 LED nominal lumen

10 W **Tunable white COB LED - 20 W/m** Lumen delivered up to 521-548 lm / Lumen maintenance: L80 B10=50,000h

Driver	Version	Length	Diffuser	Beam width	LED	K	CRI	lm	SDCM	Finishes
D DALI	BQ92	500 mm	F Opal 55%	114°	QT	2700-6500	>90	1338-1412	<3-<5	21

LED nominal lumen

1000 mm **19 W** **MID POWER LED - 19 W/m** Lumen delivered up to 1379 lm / Lumen maintenance: L80 B10=50,000h

Driver	Version	Length	Diffuser	Beam width	LED	K	CRI	lm	SDCM	Finishes
D DALI	BQ94	1000 mm	F Opal 55%	114°	HW	2700	>90	3110	<3	21
					HQ	3000	>90	3368	<3	
					WQ	3500	>90	3368	<3	

4000K (CRI >90) on request
 Warm Dimming 1800K-3000K (CRI >95) on request
 LED nominal lumen

20 W **Tunable white COB LED - 20 W/m** Lumen delivered up to 1032-1085 lm / Lumen maintenance: L80 B10=50,000h

Driver	Version	Length	Diffuser	Beam width	LED	K	CRI	lm	SDCM	Finishes
D DALI	BQ94	1000 mm	F Opal 55%	114°	QT	2700-6500	>90	2649-2796	<3-<5	21

LED nominal lumen

1500 mm **28 W** **MID POWER LED - 19 W/m** Lumen delivered up to 2069 lm / Lumen maintenance: L80 B10=50,000h

Driver	Version	Length	Diffuser	Beam width	LED	K	CRI	lm	SDCM	Finishes
D DALI	BQ97	1500 mm	F Opal 55%	114°	HW	2700	>90	4642	<3	21
					HQ	3000	>90	5027	<3	
					WQ	3500	>90	5027	<3	

4000K (CRI >90) on request
 Warm Dimming 1800K-3000K (CRI >95) on request
 LED nominal lumen

30 W **Tunable white COB LED - 20 W/m** Lumen delivered up to 1533-1611 lm / Lumen maintenance: L80 B10=50,000h

Driver	Version	Length	Diffuser	Beam width	LED	K	CRI	lm	SDCM	Finishes
D DALI	BQ97	1500 mm	F Opal 55%	114°	QT	2700-6500	>90	3934-4151	<3-<5	21

LED nominal lumen



For Track 48V - Deep
 Recessed, Surface, Surface/Pendant
 p. 110-111 / 114-115

Opal - Deep (Drop)

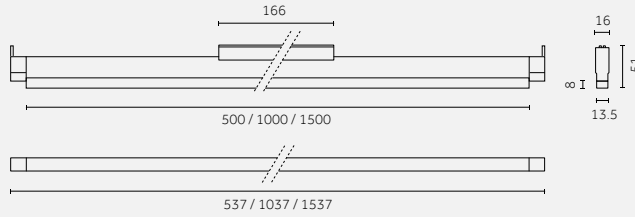
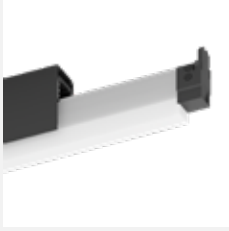

Code example:
D . **FQ92** **F** . **HW** **21**

Track 48V: p. 110-111 / 114-115
 Photometric data:
www.reggiani.net

500 mm **9 W** **MID POWER LED** - 19 W/m Lumen delivered up to 721 lm / Lumen maintenance: L80 B10=50,000h

Driver	Version	Length	Diffuser	Beam width	LED	K	CRI	lm	SDCM	Finishes
D DALI	FQ92	500 mm	F Opal55%	165° / 108°	HW	2700	>90	1555	<3	21
					HQ	3000	>90	1684	<3	
					WQ	3500	>90	1684	<3	

4000K (CRI >90) on request
 Warm dimming = 1800K-3000K (CRI >95)
 LED nominal lumen

500 mm **10 W** **Tunable white COB LED** - 20 W/m Lumen delivered up to 542-570 lm / Lumen maintenance: L80 B10=50,000h

Driver	Version	Length	Diffuser	Beam width	LED	K	CRI	lm	SDCM	Finishes
D DALI	FQ92	500 mm	F Opal55%	165° / 108°	QT	2700-6500	>90	1338-1412	<3-<5	21

LED nominal lumen

1000 mm **19 W** **MID POWER LED** - 19 W/m Lumen delivered up to 1441 lm / Lumen maintenance: L80 B10=50,000h

Driver	Version	Length	Diffuser	Beam width	LED	K	CRI	lm	SDCM	Finishes
D DALI	FQ94	1000 mm	F Opal55%	165° / 108°	HW	2700	>90	3110	<3	21
					HQ	3000	>90	3368	<3	
					WQ	3500	>90	3368	<3	

4000K (CRI >90) on request
 Warm dimming = 1800K-3000K (CRI >95)
 LED nominal lumen

1000 mm **20 W** **Tunable white COB LED** - 20 W/m Lumen delivered up to 1074-1128 lm / Lumen maintenance: L80 B10=50,000h

Driver	Version	Length	Diffuser	Beam width	LED	K	CRI	lm	SDCM	Finishes
D DALI	FQ94	1000 mm	F Opal55%	165° / 108°	QT	2700-6500	>90	2649-2796	<3-<5	21

LED nominal lumen

1500 mm **28 W** **MID POWER LED** - 19 W/m Lumen delivered up to 2162 lm / Lumen maintenance: L80 B10=50,000h

Driver	Version	Length	Diffuser	Beam width	LED	K	CRI	lm	SDCM	Finishes
D DALI	FQ97	1500 mm	F Opal55%	165° / 108°	HW	2700	>90	4642	<3	21
					HQ	3000	>90	5027	<3	
					WQ	3500	>90	5027	<3	

4000K (CRI >90) on request
 Warm dimming = 1800K-3000K (CRI >95)
 LED nominal lumen

1500 mm **30 W** **Tunable white COB LED** - 20 W/m Lumen delivered up to 1594-1675 lm / Lumen maintenance: L80 B10=50,000h

Driver	Version	Length	Diffuser	Beam width	LED	K	CRI	lm	SDCM	Finishes
D DALI	FQ97	1500 mm	F Opal55%	165° / 108°	QT	2700-6500	>90	3934-4151	<3-<5	21

LED nominal lumen



For Track 48V - Deep
 Recessed, Surface, Surface/Pendant
 p. 110-111 / 114-115



Incline Dark Performance (UGR<19)

^{EN} Incline 48V Dark Performance, available both for standard and deep tracks, is a true task light for 48V track. With carefully considered glare control and visual comfort principles, providing comfort in the workplace is assured. Multiple beam angles, lengths and additional accessories make it possible to achieve all types of task lighting requirements in all projects. Different power options give flexibility depending on the different mounting height.

^{IT} Incline 48V Dark Performance, disponibile sia per binari standard che deep, rappresenta una vera e propria soluzione tecnica per binari 48V. Grazie ai principi di controllo dell'abbagliamento, il comfort visivo sul posto di lavoro è assicurato. Le diverse opzioni di fascio luminoso, le lunghezze e gli accessori consentono di soddisfare tutti i requisiti di illuminazione per l'ufficio. Le diverse potenze offrono flessibilità a seconda dell'altezza di montaggio.

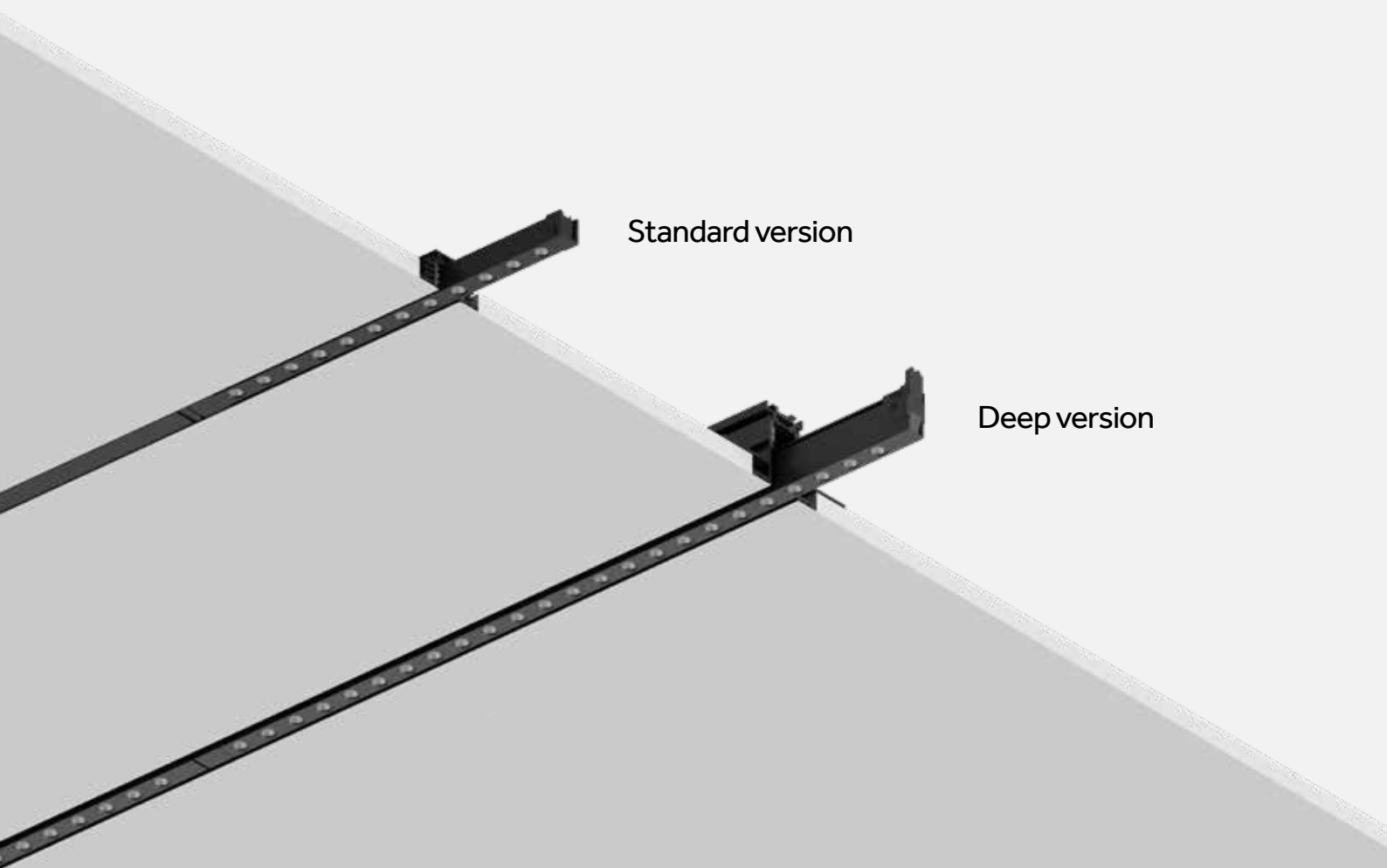



^{EN} Incline 48V Dark Performance, available both for standard and deep tracks, represents the ideal solution for task lighting.

^{IT} Incline 48V Dark Performance, disponibile sia per binari standard che deep, rappresenta una soluzione ideale per task lighting.

Incline 48V Dark Performance (UGR<19)

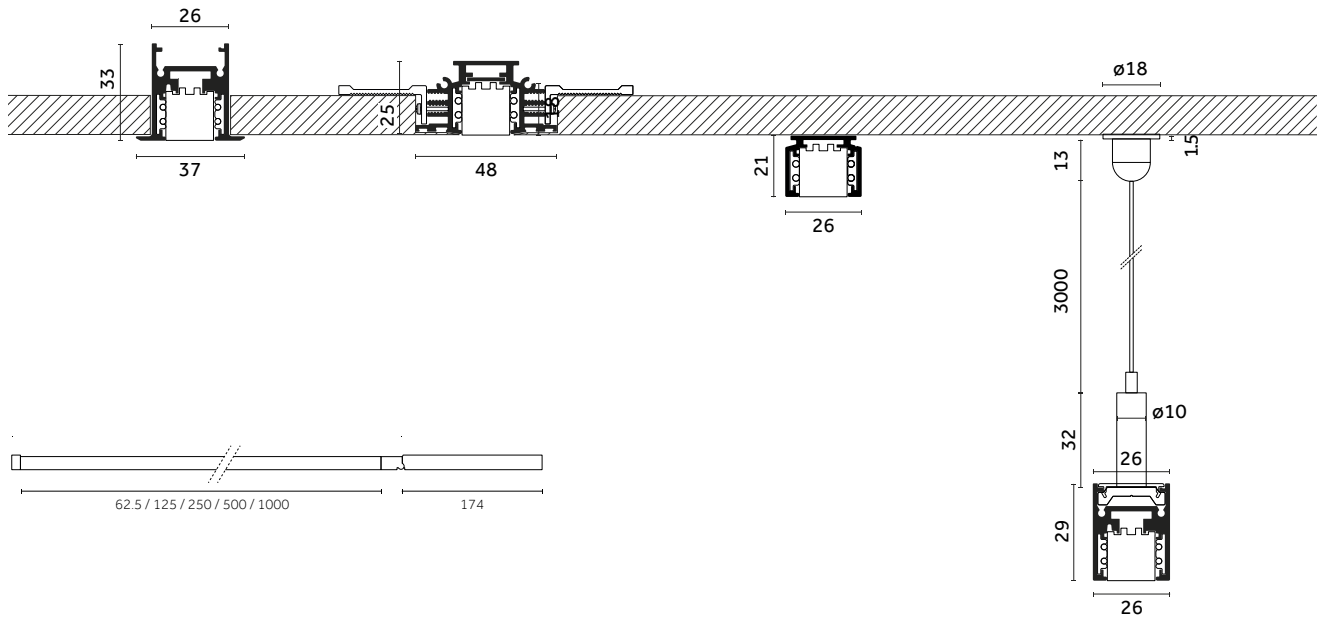

^{EN} In the standard version of Incline 48V Dark Performance (UGR<19), the driver is connected beside the product.
^{IT} Nella versione standard di Incline 48V Dark Performance (UGR<19), il driver segue la lunghezza del prodotto.

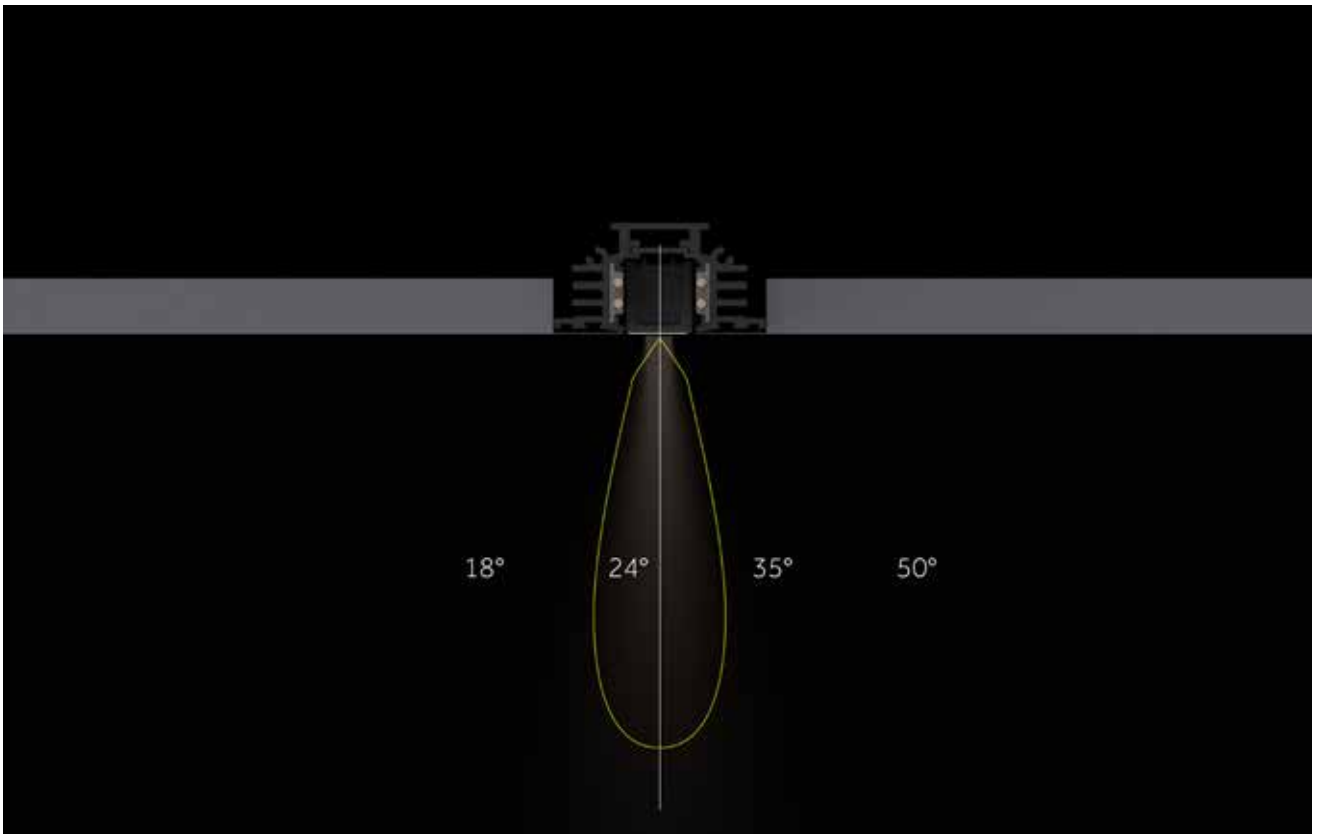

^{EN} Different beam angles are available for Incline 48V Dark Performance UGR<19: 18° - 24° - 35° - 50°.
^{IT} Diversi fasci di luce sono disponibili per Incline 48V Dark Performance UGR<19: 18° - 24° - 35° - 50°.

Incline 48V Dark Performance (UGR<19) - Deep

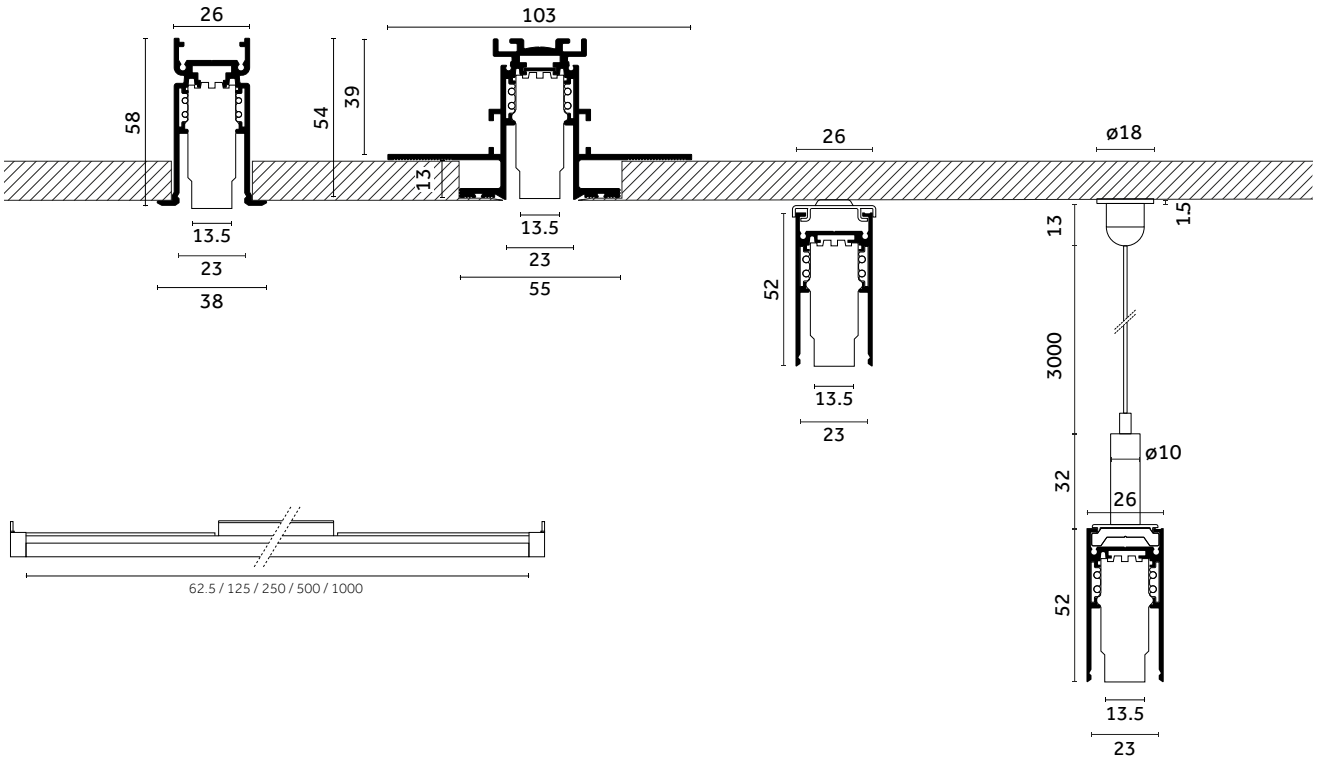

^{EN} Incline 48V Dark Performance (UGR<19)'s concealed driver disappears inside the Deep track.
^{IT} Il driver arretrato di Incline 48V Dark Performance (UGR<19) Deep scompare all'interno del binario Deep.

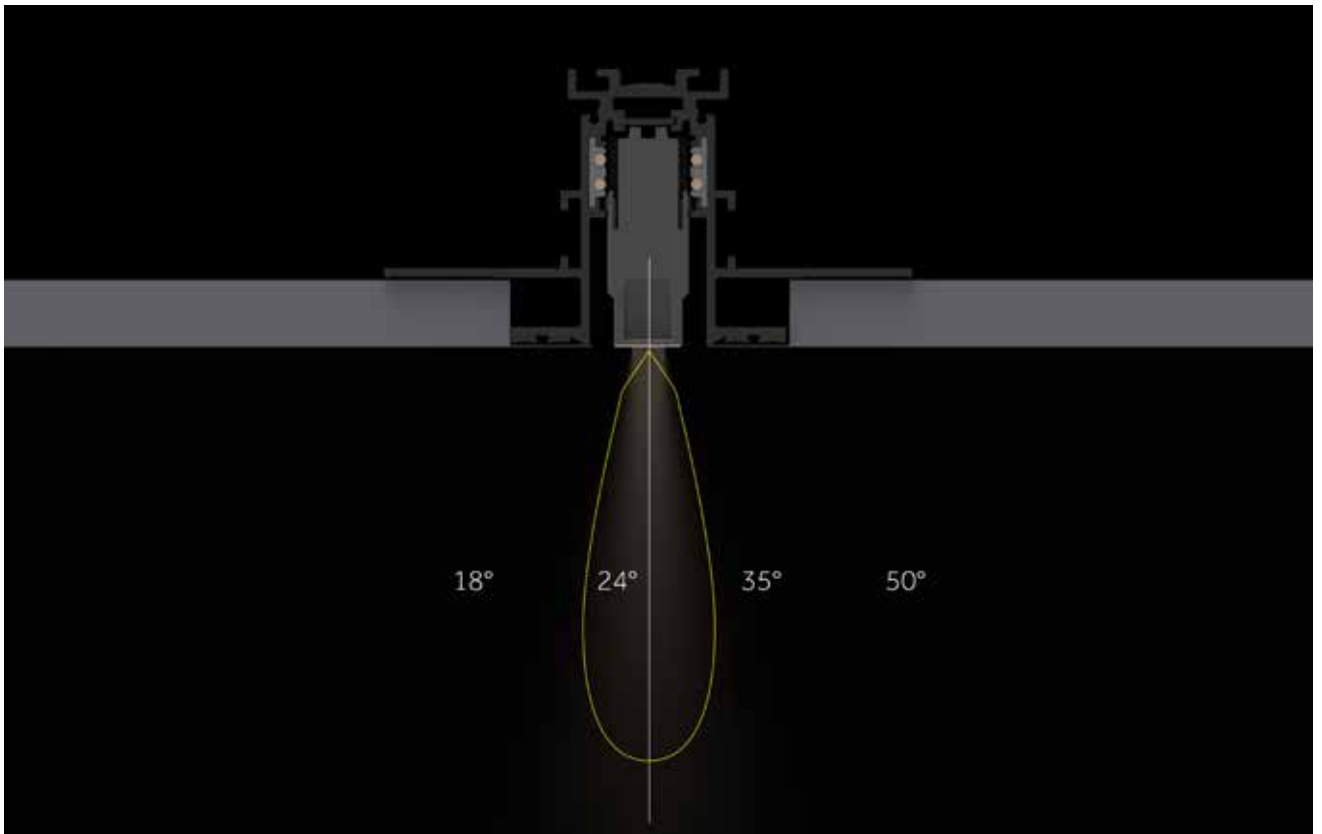

^{EN} Different beam angles are available for Incline 48V Dark Performance UGR19 - Deep: 18° - 24° - 35° - 50°.
^{IT} Diversi fasci di luce sono disponibili per Incline 48V Dark Performance UGR19 - Deep: 18° - 24° - 35° - 50°.

The magnetic accessories



EN Magnetic System for accessories
IT Sistema magnetico di attacco accessori

EN Incline 48V Dark Performance offers a wide range of optical and decorative accessories that make it even more flexible in contexts such as museums, commercial spaces, retail stores, offices and hospitality. The accessories allow you to change the light distribution, increase visual comfort or transform the light by changing both its temperature and color.

IT Incline 48V Dark Performance offre un'ampia gamma di accessori ottici e decorativi per rendere ancora più flessibile il suo utilizzo in contesti diversi come quello museale, commerciale, retail, office e hospitality. Gli accessori permettono di modificare la distribuzione luminosa, aumentare il comfort visivo o trasformare la luce cambiando temperatura o colore della luce.



Coloured filters/
Filtri colorati



Selective filters/
Filtri selettivi



Spread lens/
Lente prismatica



Honeycomb louvre/
Griglia alveolare



Opal lens/
Lente opale



Elliptical lens/
Lente ellittica



Snoot/
Cilindro anti-abbaglio



Snoot with opal filter/
Cilindro anti-abbaglio con
filtro opale



Decorative accessory/
Accessorio decorativo

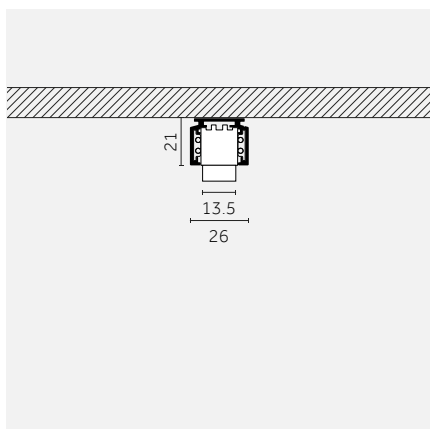

EN Incline Dark Performance + accessory
IT Incline Dark Performance + accessorio

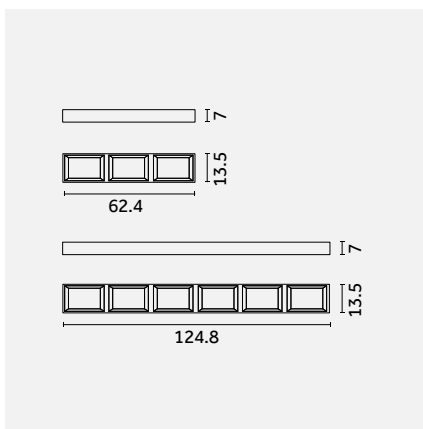

EN Accessories available in two different lengths: 62.5mm and 125mm
IT Accessori disponibili in due diverse lunghezze: 62.5mm e 125mm

Double height installation example (7m)
Esempio di installazione su doppia altezza (7m)



Products: Incline 48V Dark Performance (UGR<19) Deep - 1000mm, 22W, 3000K
 Incline 48V Opal, 1000mm - Deep (Drop) 19W, 3000K
Center distance: Incline 48V Dark Performance (UGR<19) = 2300mm
 Incline 48V Opal = 1500mm
Average illuminance: 500lx

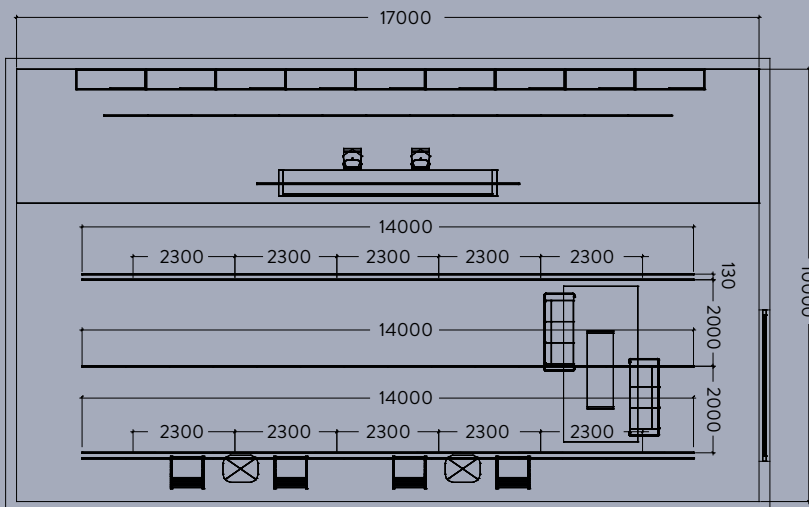

EN
IT

Standard height installation example (3m) Esempio di installazione su altezza standard (3m)







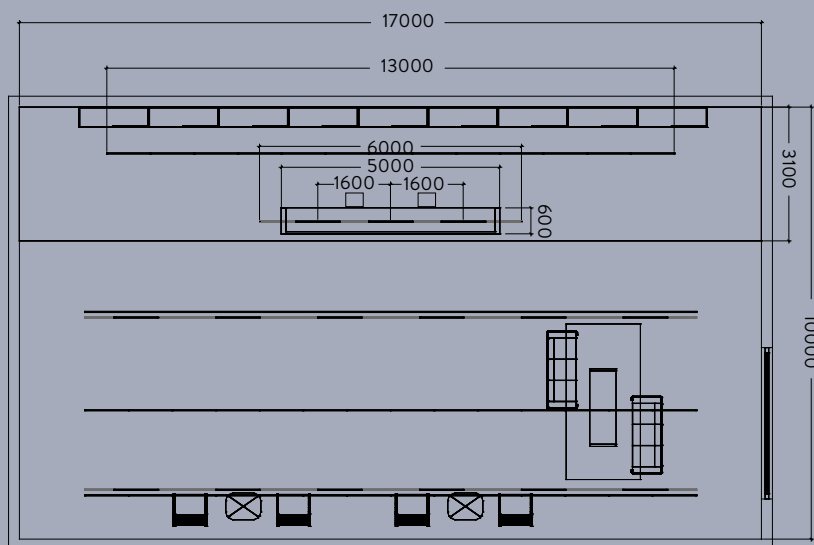

Incline 48V

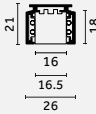
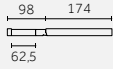
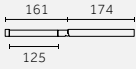
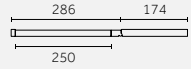
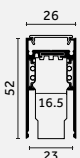

Products: Incline 48V Dark Performance (UGR<19), Deep - 500mm, 11W, 3000K
Center distance: Incline 48V Dark Performance (UGR<19) = 1600mm
Average illuminance on workplane: 1200lx



Technical info & codes

	62,5mm	125mm	250mm
<p>Incline 48V Dark Performance (UGR<19)</p> 			
	p.56	p.56	p.56
<p>Incline 48V Dark Performance (UGR<19) Deep</p> 			
	p.57	p.57	p.57
	<p>Narrow (18°) Medium (24°) Medium Wide (35°) Wide (50°)</p>	<p>Narrow (18°) Medium (24°) Medium Wide (35°) Wide (50°)</p>	<p>Narrow (18°) Medium (24°) Medium Wide (35°) Wide (50°)</p>
<p>Light source/ Sorgente luminosa</p>	<p>Dark Performance (UGR<19) HIGH POWER LED 2 W 254 lm - 275 lm L80 B20=50,000h 2700 K, 3000 K, 3500 K CRI >90 SDCM <3 On request: (4000K, CRI >90)</p> <p>—</p> <p>Dark Performance (UGR<19) Deep HIGH POWER LED 2 W 254 lm - 275 lm L80 B20=50,000h 2700 K, 3000 K, 3500 K CRI >90 SDCM <3 HIGH POWER LED 3 W 407 lm - 441 lm L80 B10=50,000h 2700 K, 3000 K, 3500 K CRI >90 SDCM <3 On request: (4000K, CRI >90)  Tunable white (2700K-6500K, CRI >90)</p>	<p>Dark Performance (UGR<19) HIGH POWER LED 4 W 508 lm - 551 lm L80 B20=50,000h 2700 K, 3000 K, 3500 K CRI >90 SDCM <3 On request: (4000K, CRI >90)</p> <p>—</p> <p>Dark Performance (UGR<19) Deep HIGH POWER LED 4 W 508 lm - 551 lm L80 B10=50,000h 2700 K, 3000 K, 3500 K CRI >90 SDCM <3 HIGH POWER LED 7 W 814 lm - 882 lm L80 B10=50,000h 2700 K, 3000 K, 3500 K CRI >90 SDCM <3 On request: (4000K, CRI >90)  Tunable white (2700K-6500K, CRI >90)</p>	<p>Dark Performance (UGR<19) HIGH POWER LED 6 W 803 lm - 870 lm L80 B20=50,000h 2700 K, 3000 K, 3500 K CRI >90 SDCM <3 On request: (4000K, CRI >90)</p> <p>—</p> <p>Dark Performance (UGR<19) Deep HIGH POWER LED 8 W 1017 lm - 1102 lm L80 B10=50,000h 2700 K, 3000 K, 3500 K CRI >90 SDCM <3 HIGH POWER LED 14 W 1628 lm - 1764 lm L80 B10=50,000h 2700 K, 3000 K, 3500 K CRI >90 SDCM <3 On request: (4000K, CRI >90)  Tunable white (2700K-6500K, CRI >90)</p>

500mm

1000mm

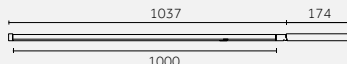
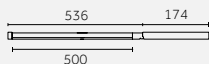

p.56

p.56

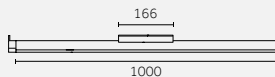
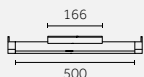

p.57

p.57

- Narrow (18°)
- Medium (24°)
- Medium Wide (35°)
- Wide (50°)

- Narrow (18°)
- Medium (24°)
- Medium Wide (35°)
- Wide (50°)

Dark Performance (UGR<19)

HIGH POWER LED
 11 W
 1606 lm - 1740 lm
 L80 B20=50,000h
 2700 K, 3000 K, 3500 K
 CRI >90
 SDCM <3
 On request:
 (4000K, CRI>90)

HIGH POWER LED

Dark Performance (UGR<19)
 22 W
 3212 lm - 3480 lm
 L80 B20=50,000h
 2700 K, 3000 K, 3500 K
 CRI >90
 SDCM <3
 On request:
 (4000K, CRI>90)

Dark Performance (UGR<19)

Deep
HIGH POWER LED
 11 W
 2034 lm - 2203 lm
 L80 B10=50,000h
 2700 K, 3000 K, 3500 K
 CRI >90
 SDCM <3
HIGH POWER LED
 27 W
 3256 lm - 3527 lm
 L80 B10=50,000h
 2700 K, 3000 K, 3500 K
 CRI >90
 SDCM <3
 On request:
 (4000K, CRI>90)
 Tunable white
 (2700K-6500K, CRI >90)

Dark Performance (UGR<19)

Deep
HIGH POWER LED
 22 W
 4067 lm - 4406 lm
 L80 B10=50,000h
 2700 K, 3000 K, 3500 K
 CRI >90
 SDCM <3
 On request:
 (4000K, CRI>90)
 Tunable white
 (2700K-6500K, CRI >90)

Dark Performance (UGR<19)

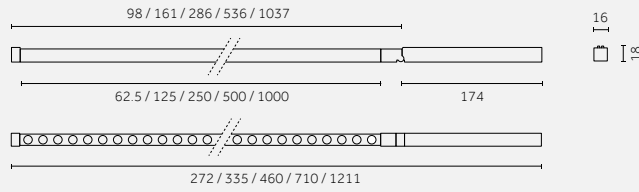

Code example:
D . **LS91** **B** . **HW** **21**

Track 48V: p. 108-109 / 112-113
 Accessories: p.59-60
 Photometric data:
 www.reggiani.net

62,5 mm (3LED)

2 W HIGH POWER LED - 22 W/m Lumen delivered up to 247 lm / Lumen maintenance: L80 B20=50,000h

Driver	Version	Length	Diffuser	Optics	LED	K	CRI	lm	SDCM	Finishes
D	DALI	62,5 mm	Dark Performance	B 18° Narrow	HW	2700	>90	254	<3	21
				E 24° Medium	HQ	3000	>90	275	<3	
				H 35° Medium-wide	WQ	3500	>90	275	<3	
				M 50° Wide						

4000K (CRI >90) on request
 LED nominal lumen

125 mm (6LED)

4 W HIGH POWER LED - 22 W/m Lumen delivered up to 494 lm / Lumen maintenance: L80 B20=50,000h

Driver	Version	Length	Diffuser	Optics	LED	K	CRI	lm	SDCM	Finishes
D	DALI	125 mm	Dark Performance	B 18° Narrow	HW	2700	>90	508	<3	21
				E 24° Medium	HQ	3000	>90	551	<3	
				H 35° Medium-wide	WQ	3500	>90	551	<3	
				M 50° Wide						

4000K (CRI >90) on request
 LED nominal lumen

250 mm (12LED)

6 W HIGH POWER LED - 22 W/m Lumen delivered up to 756 lm / Lumen maintenance: L80 B20=50,000h

Driver	Version	Length	Diffuser	Optics	LED	K	CRI	lm	SDCM	Finishes
D	DALI	250 mm	Dark Performance	B 18° Narrow	HW	2700	>90	803	<3	21
				E 24° Medium	HQ	3000	>90	870	<3	
				H 35° Medium-wide	WQ	3500	>90	870	<3	
				M 50° Wide						

4000K (CRI >90) on request
 LED nominal lumen

500 mm (24LED)

11 W HIGH POWER LED - 22 W/m Lumen delivered up to 1513 lm / Lumen maintenance: L80 B20=50,000h

Driver	Version	Length	Diffuser	Optics	LED	K	CRI	lm	SDCM	Finishes
D	DALI	500 mm	Dark Performance	B 18° Narrow	HW	2700	>90	1606	<3	21
				E 24° Medium	HQ	3000	>90	1740	<3	
				H 35° Medium-wide	WQ	3500	>90	1740	<3	
				M 50° Wide						

4000K (CRI >90) on request
 LED nominal lumen

1000 mm (48LED)

22 W HIGH POWER LED - 22 W/m Lumen delivered up to 3026 lm / Lumen maintenance: L80 B20=50,000h

Driver	Version	Length	Diffuser	Optics	LED	K	CRI	lm	SDCM	Finishes
D	DALI	1000 mm	Dark Performance	B 18° Narrow	HW	2700	>90	3212	<3	21
				E 24° Medium	HQ	3000	>90	3480	<3	
				H 35° Medium-wide	WQ	3500	>90	3480	<3	
				M 50° Wide						

4000K (CRI >90) on request
 LED nominal lumen



For Track 48V
 Recessed, Surface, Surface/Pendant
 p. 108-109 / 112-113



For Traceline Track 48V
 Surface/Pendant
 Pendant Indirect
 Deep Pendant Direct / Indirect
 visit reggiani.net

Dark Performance (UGR<19) Deep

0.09 0.11 0.15 0.24 0.46 Risk 1 IP40 850°

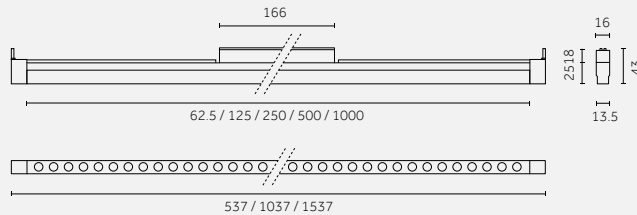

Code example:

D . KQ90 B . HW 21

Track 48V: p. 110-111 / 114-115

Accessories: p.59-60

Photometric data:

www.reggiani.net

62,5 mm (3LED)

2 W HIGH POWER LED - 22 W/m Lumen delivered up to 266 lm / Lumen maintenance: L80 B10=50,000h

Driver	Version	Length	Diffuser	Optics	LED	K	CRI	lm	SDCM	Finishes
D DALI	KQ90	62,5 mm	Dark Performance	B 18° Narrow	HW	2700	>90	254	<3	21
				E 24° Medium	HQ	3000	>90	275	<3	
				H 35° Medium-wide	WQ	3500	>90	275	<3	
				M 50° Wide						

4000K (CRI >90) on request
Tunable white 2700K-6500K (CRI >90) on request
LED nominal lumen

3 W HIGH POWER LED - 55 W/m Lumen delivered up to 396 lm / Lumen maintenance: L80 B10=50,000h

Driver	Version	Length	Diffuser	Optics	LED	K	CRI	lm	SDCM	Finishes
D DALI	LQ91	62,5 mm	Dark Performance	B 18° Narrow	HW	2700	>90	407	<3	21
				E 24° Medium	HQ	3000	>90	441	<3	
				H 35° Medium-wide	WQ	3500	>90	441	<3	
				M 50° Wide						

4000K (CRI >90) on request
Tunable white 2700K-6500K (CRI >90) on request
LED nominal lumen

125 mm (6LED)

4 W HIGH POWER LED - 22 W/m Lumen delivered up to 494 lm / Lumen maintenance: L80 B10=50,000h

Driver	Version	Length	Diffuser	Optics	LED	K	CRI	lm	SDCM	Finishes
D DALI	KQ91	125 mm	Dark Performance	B 18° Narrow	HW	2700	>90	508	<3	21
				E 24° Medium	HQ	3000	>90	551	<3	
				H 35° Medium-wide	WQ	3500	>90	551	<3	
				M 50° Wide						

4000K (CRI >90) on request
Tunable white 2700K-6500K (CRI >90) on request
LED nominal lumen

7 W HIGH POWER LED - 55 W/m Lumen delivered up to 792 lm / Lumen maintenance: L80 B10=50,000h

Driver	Version	Length	Diffuser	Optics	LED	K	CRI	lm	SDCM	Finishes
D DALI	LQ92	125 mm	Dark Performance	B 18° Narrow	HW	2700	>90	814	<3	21
				E 24° Medium	HQ	3000	>90	882	<3	
				H 35° Medium-wide	WQ	3500	>90	882	<3	
				M 50° Wide						

4000K (CRI >90) on request
Tunable white 2700K-6500K (CRI >90) on request
LED nominal lumen

250 mm (12LED)

8 W HIGH POWER LED - 22 W/m Lumen delivered up to 808 lm / Lumen maintenance: L80 B10=50,000h

Driver	Version	Length	Diffuser	Optics	LED	K	CRI	lm	SDCM	Finishes
D DALI	KQ92	250 mm	Dark Performance	B 18° Narrow	HW	2700	>90	1017	<3	21
				E 24° Medium	HQ	3000	>90	1102	<3	
				H 35° Medium-wide	WQ	3500	>90	1102	<3	
				M 50° Wide						

4000K (CRI >90) on request
Tunable white 2700K-6500K (CRI >90) on request
LED nominal lumen

14 W HIGH POWER LED - 55 W/m Lumen delivered up to 1295 lm / Lumen maintenance: L80 B10=50,000h

Driver	Version	Length	Diffuser	Optics	LED	K	CRI	lm	SDCM	Finishes
D DALI	LQ93	250 mm	Dark Performance	B 18° Narrow	HW	2700	>90	1628	<3	21
				E 24° Medium	HQ	3000	>90	1764	<3	
				H 35° Medium-wide	WQ	3500	>90	1764	<3	
				M 50° Wide						

4000K (CRI >90) on request
Tunable white 2700K-6500K (CRI >90) on request
LED nominal lumen



For Track 48V - Deep
Recessed, Surface, Surface/Pendant
p. 110-111 / 114-115

500 mm (24LED)

11 W		MID POWER LED - 22 W/m		Lumen delivered up to 1617 lm / Lumen maintenance: L80 B10=50,000h						
Driver	Version	Length	Diffuser	Optics	LED	K	CRI	lm	SDCM	Finishes
D DALI	KQ93	500 mm	Dark Performance	B 18° Narrow	HW	2700	>90	2034	<3	21
				E 24° Medium	HQ	3000	>90	2203	<3	
				H 35° Medium-wide	WQ	3500	>90	2203	<3	
				M 50° Wide						

4000K (CRI >90) on request
Tunable white 2700K-6500K (CRI >90) on request
LED nominal lumen

27 W **HIGH POWER LED - 55 W/m**

27 W		HIGH POWER LED - 55 W/m		Lumen delivered up to 2591 lm / Lumen maintenance: L80 B10=50,000h						
Driver	Version	Length	Diffuser	Optics	LED	K	CRI	lm	SDCM	Finishes
D DALI	LQ95	500 mm	Dark Performance	B 18° Narrow	HW	2700	>90	3256	<3	21
				E 24° Medium	HQ	3000	>90	3527	<3	
				H 35° Medium-wide	WQ	3500	>90	3527	<3	
				M 50° Wide						

4000K (CRI >90) on request
Tunable white 2700K-6500K (CRI >90) on request
LED nominal lumen

1000 mm (48LED)

22 W		MID POWER LED - 22 W/m		Lumen delivered up to 3234 lm / Lumen maintenance: L80 B10=50,000h						
Driver	Version	Length	Diffuser	Optics	LED	K	CRI	lm	SDCM	Finishes
D DALI	KQ95	1000 mm	Dark Performance	B 18° Narrow	HW	2700	>90	4067	<3	21
				E 24° Medium	HQ	3000	>90	4406	<3	
				H 35° Medium-wide	WQ	3500	>90	4406	<3	
				M 50° Wide						

4000K (CRI >90) on request
Tunable white 2700K-6500K (CRI >90) on request
LED nominal lumen



For Track 48V - Deep
Recessed, Surface, Surface/Pendant
p. 110-111 / 114-115

Accessories

Incline 48V - Dark Performance (UGR<19) - 62,5 mm

Colored filters/ Filtri colorati



Description	Code
Square holder with colored filter/ Holder quadrato con filtro colorato	0.27305.004A
For 3X LED	0.27305.005A
	0.27305.006A
	0.27305.007A
Colour:	0.27305.008A
4A Red 6A Blue 8A Yellow	0.27305.009A
5A Green 7A Pink 9A Orange	

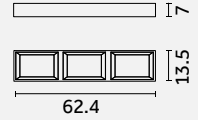

Selective filters/ Filtri selettivi



Description	Code
Square holder with 3000K-2700K filter/ Holder con filtro 3000K-2700K	0.27306.0000
For 3X LED	



Description	Code
Square holder with 2700K-2000K filter/ Holder con filtro 2700K-2000K	0.27309.0000
For 3X LED	



Description	Code
Square holder with 2700K-2500K filter/ Holder con filtro 2700K-2500K	0.27307.0000
For 3X LED	



Description	Code
Square holder with 3000K-3500K filter/ Holder con filtro 3000K-3500K	0.27310.0000
For 3X LED	



Description	Code
Square holder with 2700K-2200K filter/ Holder con filtro 2700K-2200K	0.27308.0000
For 3X LED	



Description	Code
Square holder with 3000K-4000K filter/ Holder con filtro 3000K-4000K	0.27311.0000
For 3X LED	

Optics accessories/ Accessori ottiche



Description	Code
Snoot with opal filter/ Cilindro anti-abbaglio con filtro opale	0.27301.0021
For 3X LED	



Description	Code
Square holder with opal lens/ Holder con lente opale	0.27313.0000
For 3X LED	



Description	Code
Snoot/ Cilindro anti-abbaglio	0.27302.0021
For 3X LED	



Description	Code
Square holder with spread lens/ Holder con lente prismatica	0.27314.0000
For 3X LED	



Description	Code
Square holder with elliptical lens/ Holder con filtro ellittico rigato	0.27312.0000
For 3X LED	



Description	Code
Square holder with honeycomb/ Holder con griglia alveolare	0.27325.0000
For 3X LED	

Decorative accessories/ Accessori decorativi



Description	Code
Decorative frosted attachment/ Accessorio decorativo opaco	0.27327.0000
For 3X LED	



Incline 48V - Dark Performance (UGR<19) - 125 mm

Colored filters/ Filtri colorati



Description	Code
Square holder with colored filter/ Holder quadrato con filtro colorato	0.27332.004A
For 6X LED	0.27332.005A
	0.27332.006A
	0.27332.007A
Colour:	0.27332.008A
4A Red 6A Blue 8A Yellow	0.27332.009A
5A Green 7A Pink 9A Orange	

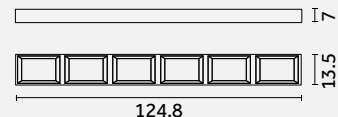

Selective filters/ Filtri selettivi



Description	Code
Square holder with 3000K-2700K filter/ Holder con filtro 3000K-2700K	0.27333.0000
For 6X LED	



Description	Code
Square holder with 2700K-2000K filter/ Holder con filtro 2700K-2000K	0.27336.0000
For 6X LED	



Description	Code
Square holder with 2700K-2500K filter/ Holder con filtro 2700K-2500K	0.27334.0000
For 6X LED	



Description	Code
Square holder with 3000K-3500K filter/ Holder con filtro 3000K-3500K	0.27337.0000
For 6X LED	

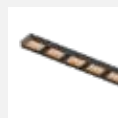

Description	Code
Square holder with 2700K-2200K filter/ Holder con filtro 2700K-2200K	0.27335.0000
For 6X LED	



Description	Code
Square holder with 3000K-4000K filter/ Holder con filtro 3000K-4000K	0.27338.0000
For 6X LED	

Optics accessories/ Accessori ottiche



Description	Code
Snoot with opal filter/ Cilindro anti-abbaglio con filtro opale	0.27331.0021
For 6X LED	



Description	Code
Square holder with opal lens/ Holder con lente opale	0.27340.0000
For 6X LED	



Description	Code
Snoot/ Cilindro anti-abbaglio	0.27328.0021
For 6X LED	



Description	Code
Square holder with spread lens/ Holder con lente prismatica	0.27341.0000
For 6X LED	



Description	Code
Square holder with elliptical lens/ Holder con filtro ellittico rigato	0.27339.0000
For 6X LED	



Description	Code
Square holder with honeycomb/ Holder con griglia alveolare	0.27329.0000
For 6X LED	

Decorative accessories/ Accessori decorativi



Description	Code
Decorative frosted attachment/ Accessorio decorativo opaco	0.27342.0000
For 6X LED	

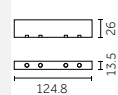

Incline Dark Performance (UGR<15)

EN Combine exceptional lumen output with a controlled, no glare result. Incline Dark Performance UGR<15 offers better visual comfort and high efficacy. The on request Tunable White option makes the product even more flexible.

IT Combina lumen output eccezionali con un risultato controllato e senza abbaglio. Incline Dark Performance UGR<15 offre un ottimo comfort visivo ed alta efficacia. La versione Tunable White su richiesta rende il prodotto una soluzione ancora più flessibile.

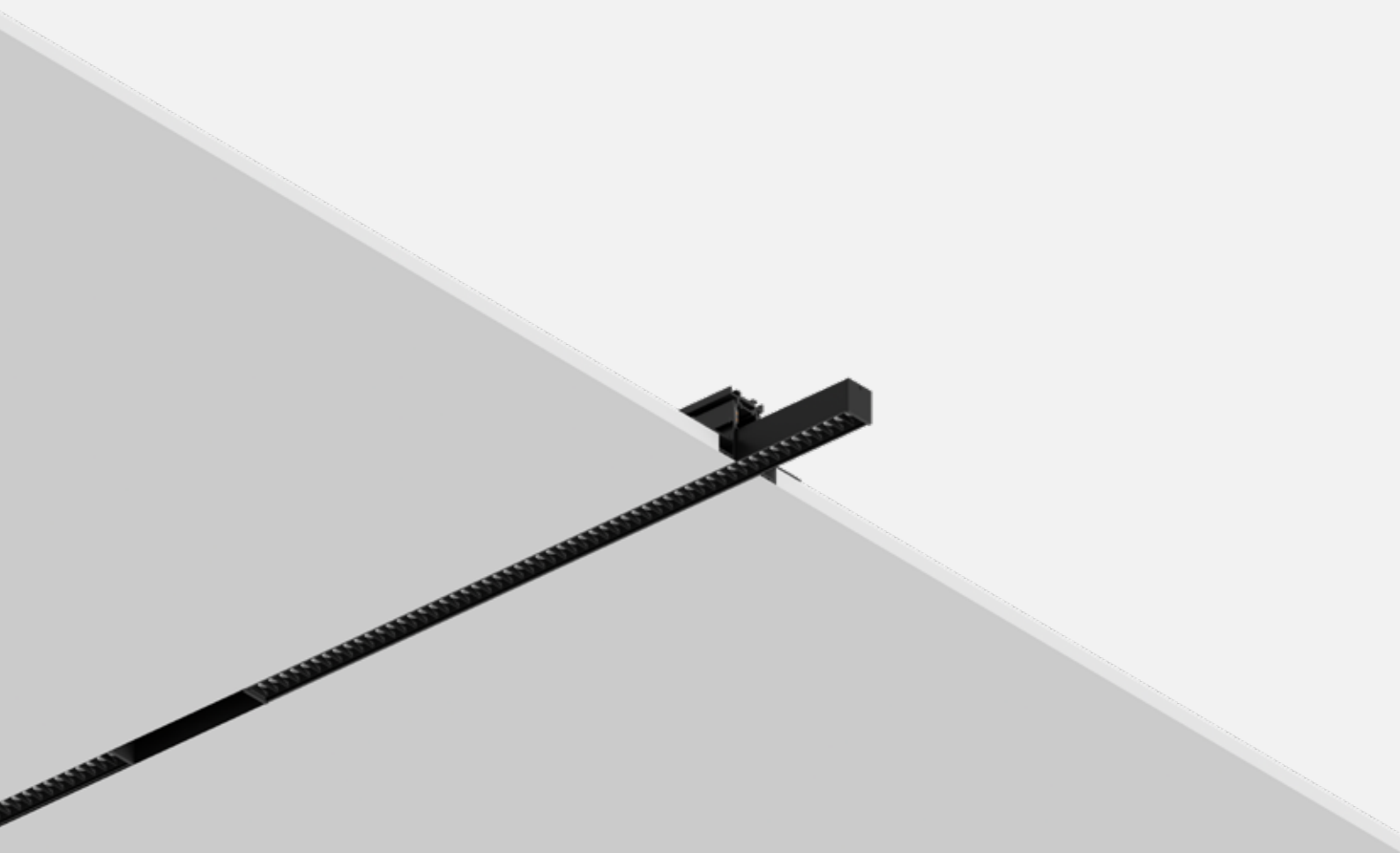

Incline 48V Dark Performance (UGR<15) - Deep

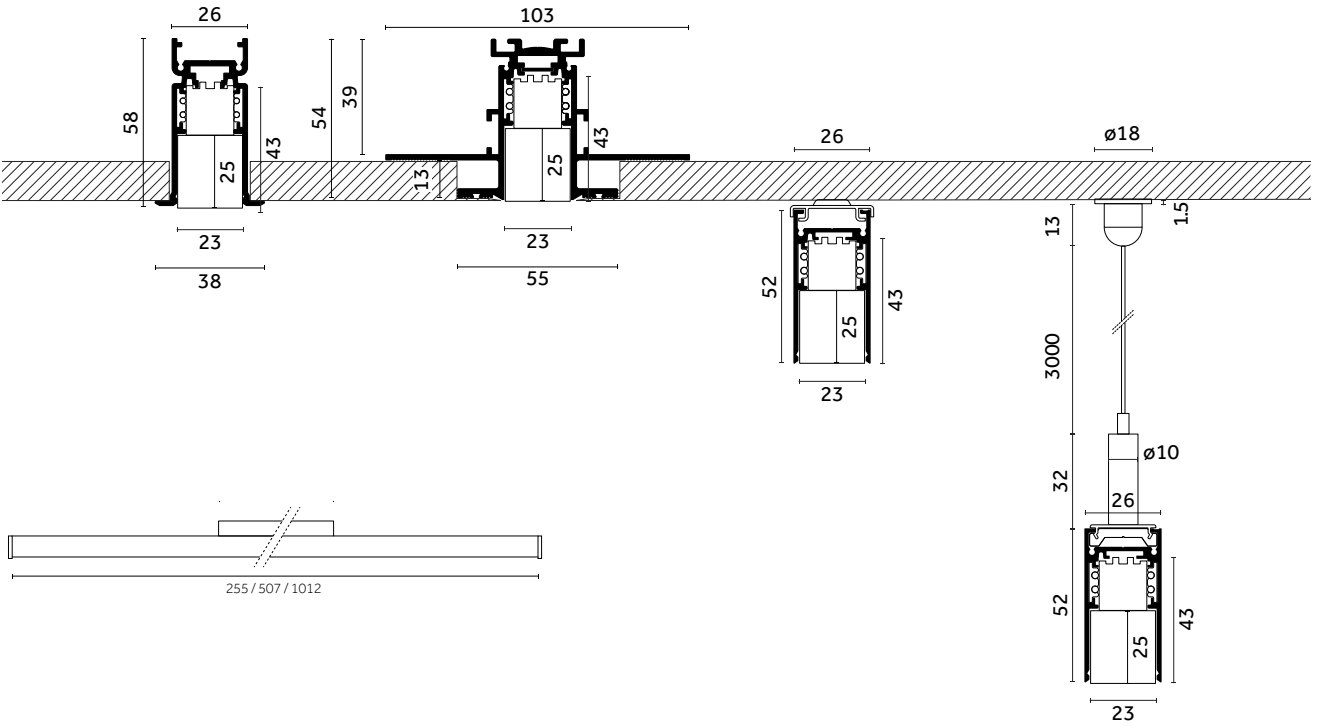

^{EN} Incline 48V Dark Performance (UGR<15) - Deep's concealed driver disappears inside the Deep track.
^{IT} Il driver arretrato di Incline 48V Dark Performance (UGR<15) - Deep, scompare all'interno del binario Deep.

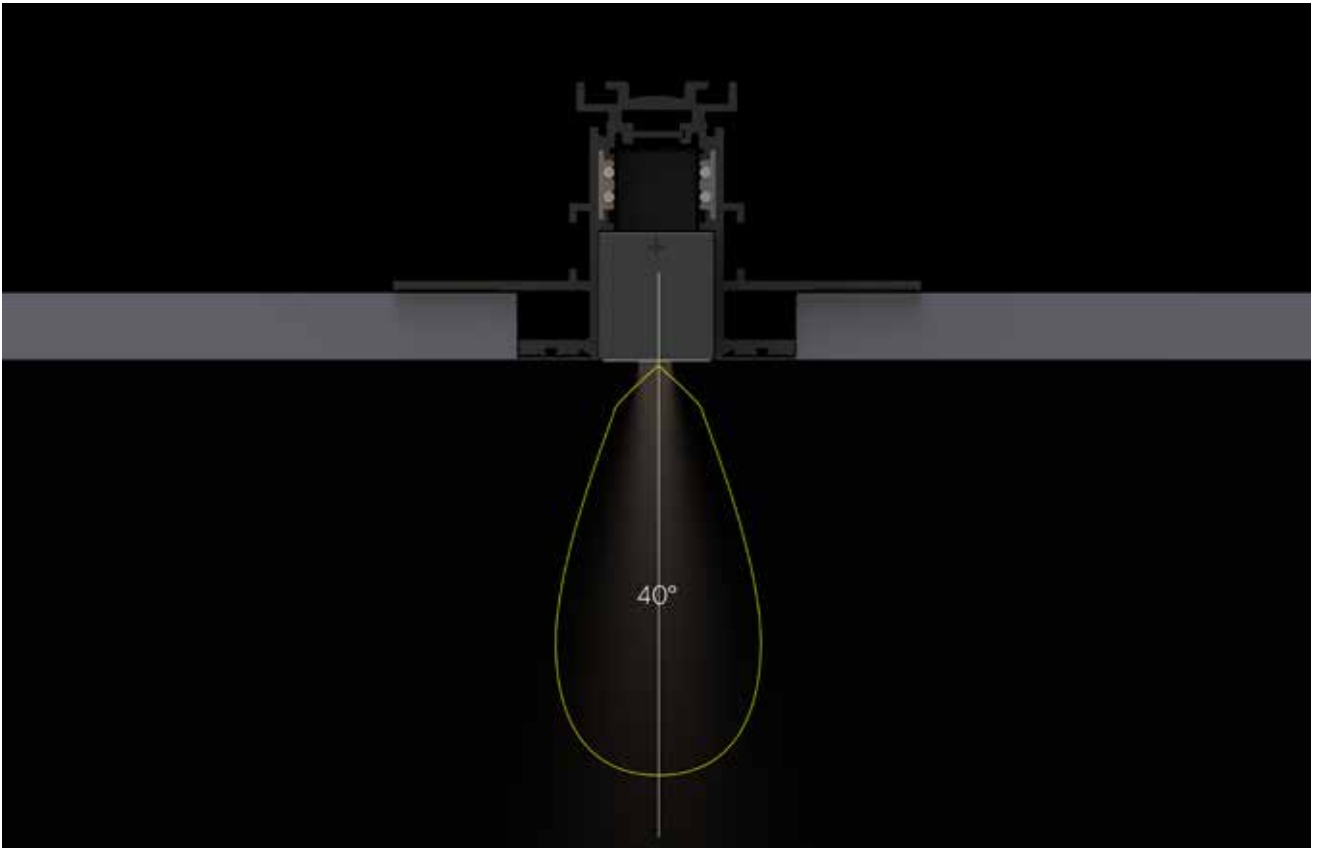

^{EN} The medium beam angle offered for Incline 48V Dark Performance UGR 15 (40°) answers to general office lighting requirements.
^{IT} Il fascio medio offerto per Incline 48V Dark Performance UGR 15 (40°) risponde ai requisiti per un'ottima illuminazione da ufficio.

UGR<15

EN UGR<15 ensures a high level of glare control, without giving up exceptional lighting results as high lumen outputs are assured. The reflector, which is made up of different lighting cells, is an efficient and precise lighting tool, assuring an high lumen output.

IT UGR<15 assicura un elevato livello di controllo dell'abbaglio, senza rinunciare ad un eccellente risultato illuminotecnico. Il riflettore, formato da celle, rappresenta uno strumento efficiente e preciso e assicura un elevato lumen output.



EN Reflector in gold finish on request
IT Riflettore in finitura oro su richiesta

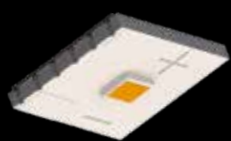
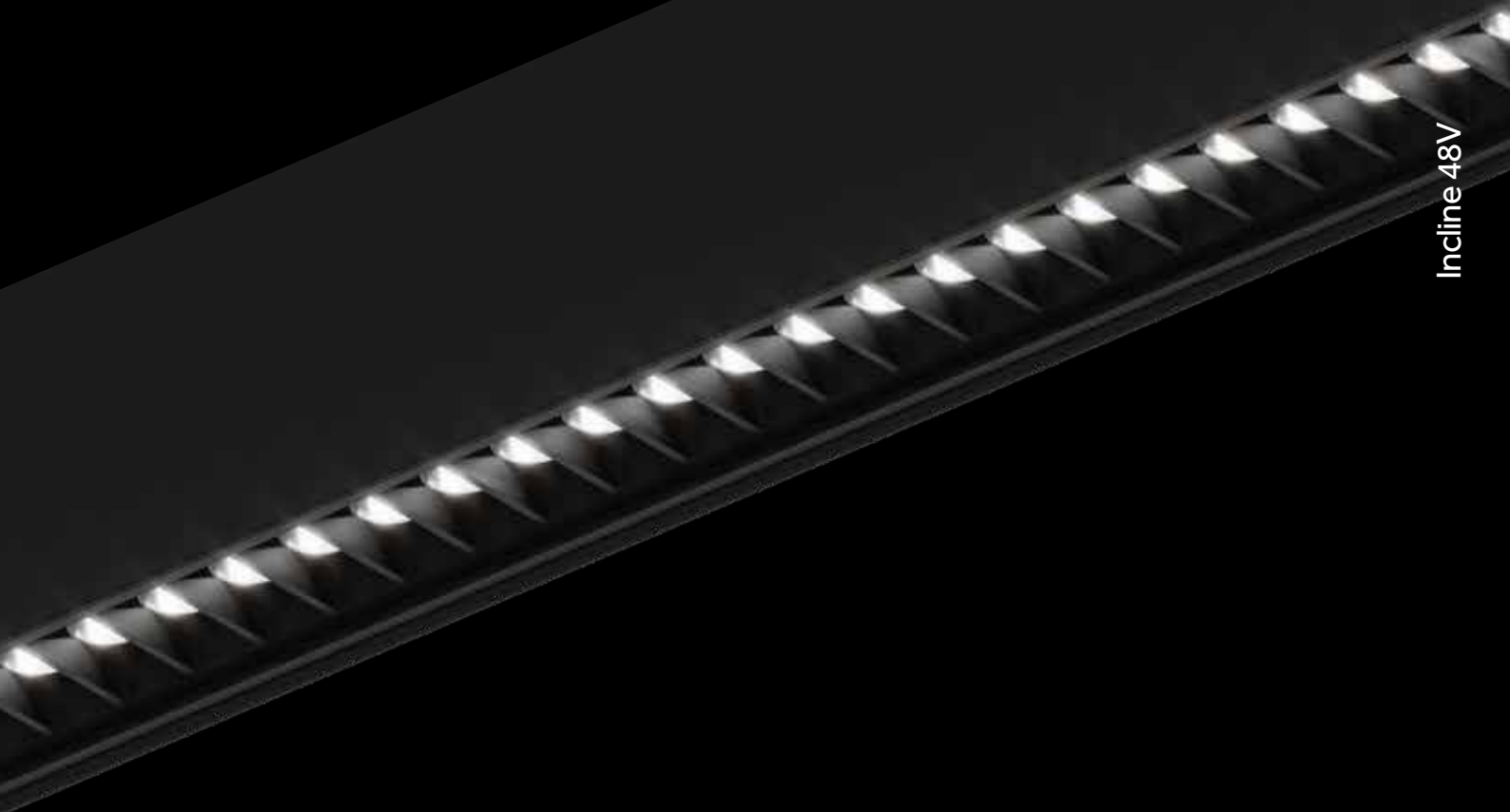

^{EN} POWER LED with excellent performances and high colour rendering CRI>90.
^{IT} POWER LED dalle prestazioni eccellenti e resa cromatica elevata CRI>90.



^{EN} PMMA collimator micro lens with surface treatment for maximum colour homogeneity throughout all distribution width.
^{IT} Micro lente collimatrice in PMMA con trattamento superficiale per la massima omogeneità del colore per tutta l'ampiezza della distribuzione.



^{EN} Reflector in metallic mirrored thermoplastic for high cut-off and reduction of the portion of uncontrolled direct light.
^{IT} Riflettore in termoplastica metallizzata specchiata per elevato cut-off e riduzione della porzione di luce diretta non controllata



^{EN} Glossy black plastic screen for glare reduction and lower UGR values.
^{IT} Schermo in plastica nera lucida per riduzione dell'abbaglio e valori UGR più contenuti

EN
IT





Standard height installation example (3m)
Esempio di installazione su altezza standard (3m)

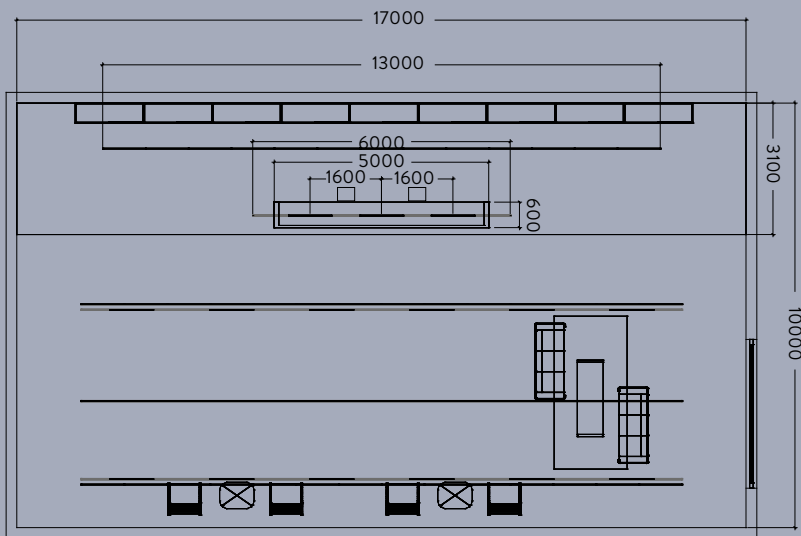

Products: Incline 48V Dark Performance (UGR<15), 500mm, 11W, 3000K
Center distance: Incline 48V Dark Performance (UGR<15), 500mm, 11W, 3000K = 2300mm
Average illuminance on workplane: 800lx

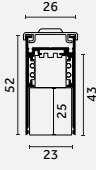
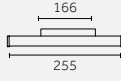
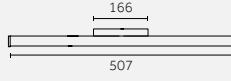
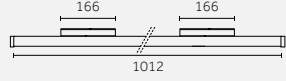

Technical info & codes

	250mm	500mm	1000mm
<p>Incline 48V Dark Performance (UGR<15)</p> 			
	p.71	p.71	p.71
	Medium-wide (40°)	Medium-wide (40°)	Medium-wide (40°)
<p>Light source/ Sorgente luminosa</p>	<p>HIGH POWER LED 5W 728lm - 810lm L80 B20=50,000h 2700K, 3000K, 3500K CRI >90 SDCM <3</p> <p>On request: (4000K, CRI >90)</p> <p> Tunable white (2700K-6500K, CRI >90)</p>	<p>HIGH POWER LED 11W 1456lm - 1620lm L80 B20=50,000h 2700K, 3000K, 3500K CRI >90 SDCM <3</p> <p>On request: (4000K, CRI >90)</p> <p> Tunable white (2700K-6500K, CRI >90)</p>	<p>HIGH POWER LED 22W 2912lm - 3240lm L80 B20=50,000h 2700K, 3000K, 3500K CRI >90 SDCM <3</p> <p>On request: (4000K, CRI >90)</p> <p> Tunable white (2700K-6500K, CRI >90)</p>

Dark Performance (UGR<15) Deep

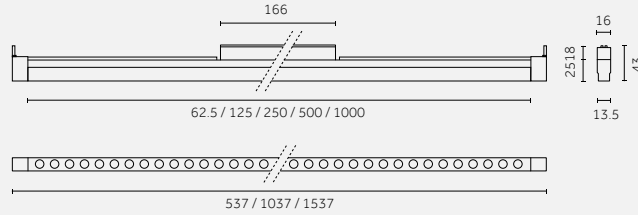
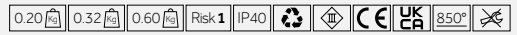

Code example:

D . TQ92 H . HW 21

Track 48V: p. 110-111 / 114-115
 Photometric data:
 www.reggiani.net

250 mm

5 W	HIGH POWER LED - 22 W/m		Lumen delivered up to 529 lm / Lumen maintenance: L80 B20=50,000h							
Driver	Version	Length	Diffuser	Optics	LED	K	CRI	lm	SDCM	Finishes
D DALI	TQ92	250 mm	Dark Performance	H 40° Medium-wide	HW	2700	>90	728	<3	21
					HQ	3000	>90	784	<3	
					WQ	3500	>90	810	<3	
4000K (CRI >90) on request Tunable white 2700K-6500K (CRI >90) on request LED nominal lumen										

500 mm

11 W	HIGH POWER LED - 22 W/m		Lumen delivered up to 1059 lm / Lumen maintenance: L80 B20=50,000h							
Driver	Version	Length	Diffuser	Optics	LED	K	CRI	lm	SDCM	Finishes
D DALI	TQ93	500 mm	Dark Performance	H 40° Medium-wide	HW	2700	>90	1456	<3	21
					HQ	3000	>90	1568	<3	
					WQ	3500	>90	1620	<3	
4000K (CRI >90) on request Tunable white 2700K-6500K (CRI >90) on request LED nominal lumen										

1000 mm

22 W	HIGH POWER LED - 22 W/m		Lumen delivered up to 2118 lm / Lumen maintenance: L80 B20=50,000h							
Driver	Version	Length	Diffuser	Optics	LED	K	CRI	lm	SDCM	Finishes
D DALI	TQ95	1000 mm	Dark Performance	H 40° Medium-wide	HW	2700	>90	2912	<3	21
					HQ	3000	>90	3136	<3	
					WQ	3500	>90	3240	<3	
4000K (CRI >90) on request Tunable white 2700K-6500K (CRI >90) on request LED nominal lumen										



For Track 48V - Deep
 Recessed, Surface, Surface/Pendant
 p. 110-111 / 114-115

Incline 48V Dark Performance Adjustable

EN Incline 48V Dark Performance Adjustable is the adjustable version of the Incline family and the perfect solution for efficient and precise accent lighting. Adjustable in both the vertical (360°) and horizontal axis (-45°/+45°), the product ensures maximum flexibility. The ability to integrate it into architectural structures, the multiple beam options and the different lengths offered make it possible to meet all kinds of lighting needs.

IT Incline 48V Dark Performance Adjustable è la versione orientabile della famiglia Incline ed la soluzione perfetta per un'illuminazione d'accento efficiente e precisa. L'orientabilità sia sull'asse verticale (360°) che orizzontale (-45°/+45°) assicura la massima flessibilità. La capacità di integrarsi nelle strutture architettoniche, i molteplici fasci di luce e le diverse lunghezze offerte consentono di soddisfare ogni tipo di esigenza di illuminazione.

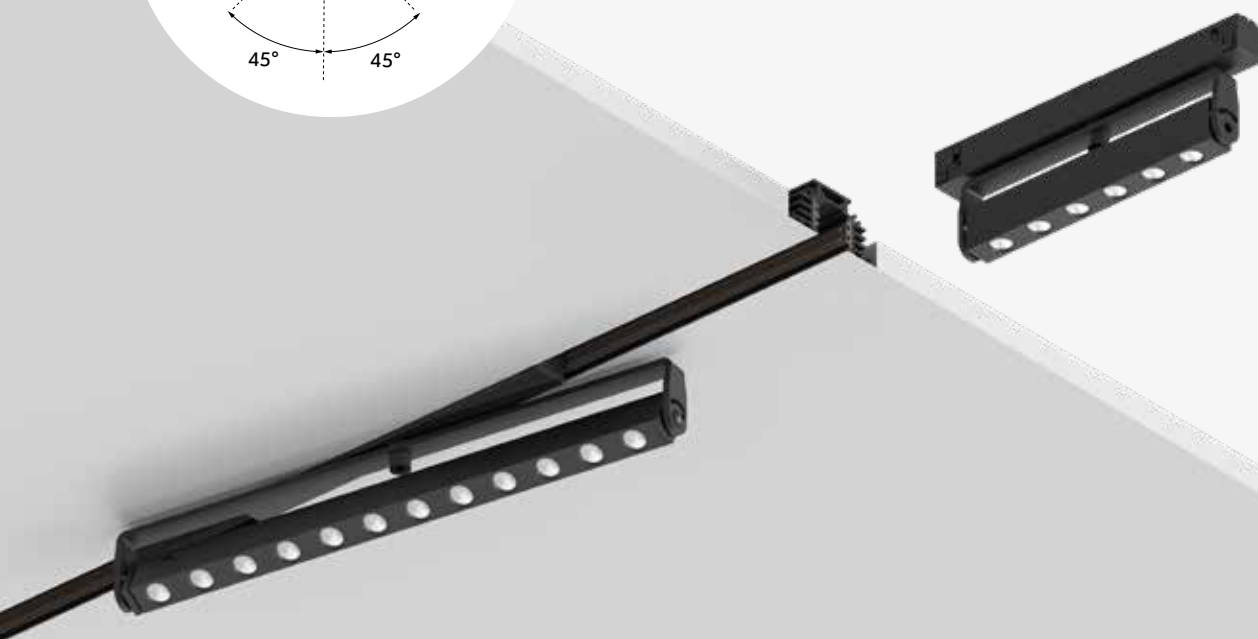
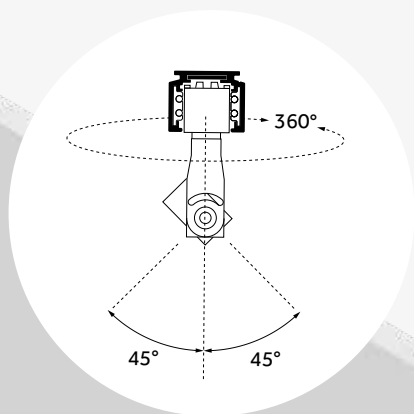

Incline 48V Dark Performance Adjustable

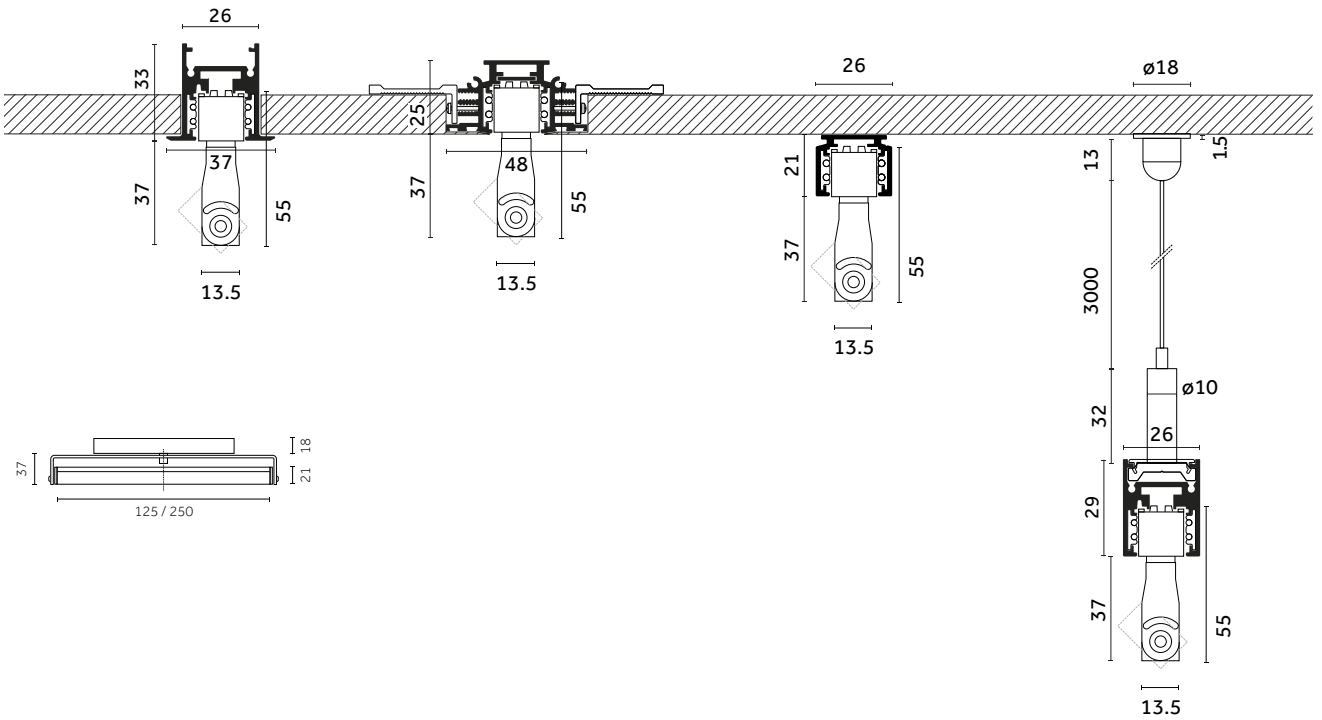

^{EN} Incline 48V Dark Performance Adjustable's concealed driver disappears inside the standard track.
^{IT} Il driver arretrato di Incline 48V Dark Performance Adjustable scompare all'interno dei binari standard.

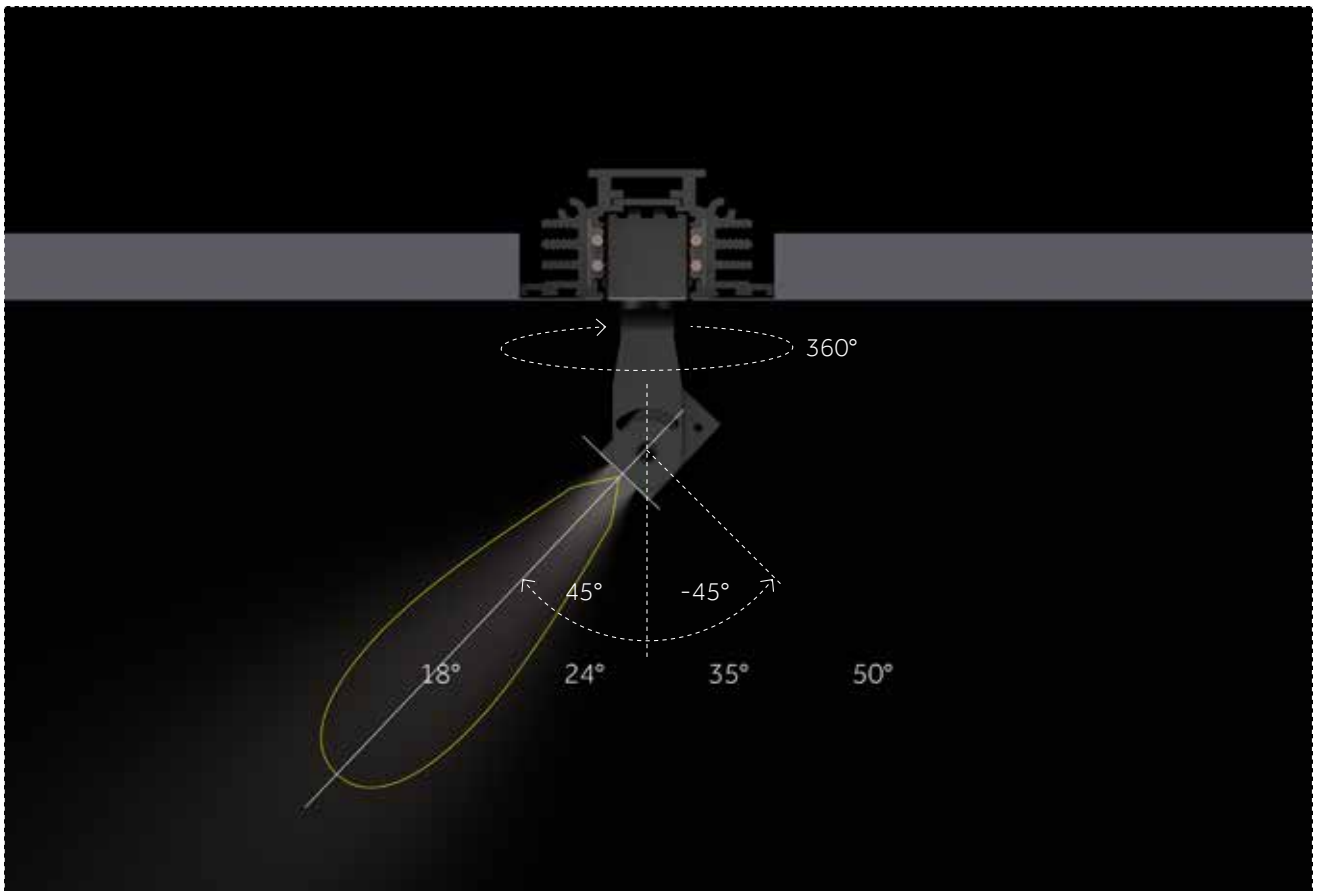

^{EN} Different beam angles are available for Incline 48V Dark Performance UGR19 - Deep: 18° - 24° - 35° - 50°.
^{IT} Diversi fasci di luce sono disponibili per Incline 48V Dark Performance UGR19 - Deep: 18° - 24° - 35° - 50°.



EN The adjustability of Incline 48V on the two axes allows the beam to be directed precisely towards the object you want to illuminate, providing great flexibility. The ability to rotate Incline 48V Adjustable 360° on the vertical axis also allows the product to be rotated perpendicular to the direction of the track.

IT L'orientabilità di Incline 48V sui due assi, permette di direzionare il fascio di luce in modo preciso verso l'oggetto che vogliamo illuminare, garantendo grande flessibilità. La possibilità di ruotare Incline 48V Adjustable di 360° sull'asse verticale permette di ruotare il prodotto anche in perpendicolare rispetto alla direzione del binario.

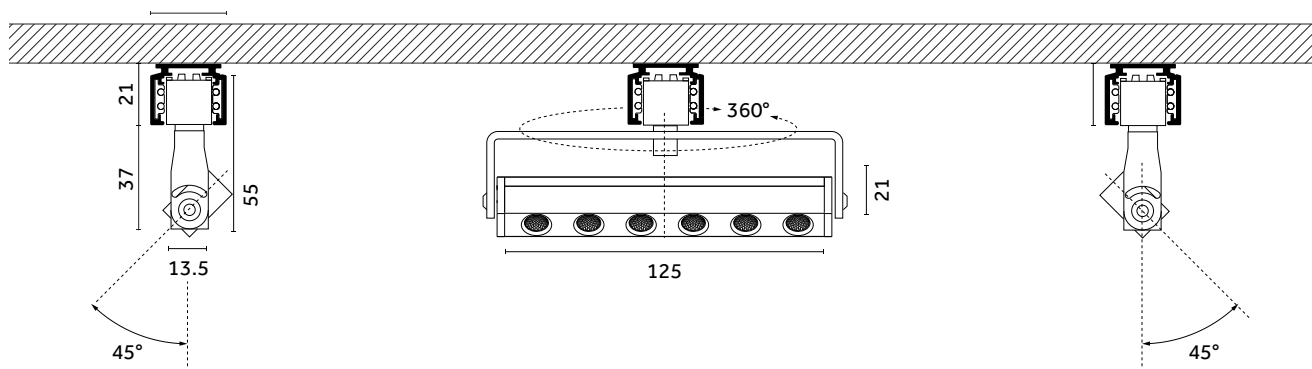

On request

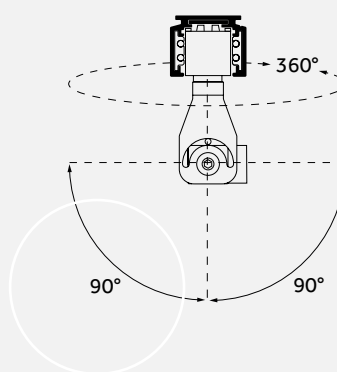



EN Thanks to the small size of Incline 48V Dark Performance Adjustable, the product can be easily hidden in architectural details such as beams and wooden slats.

IT Grazie alle dimensioni ridotte di Incline 48V Dark Performance Adjustable, il prodotto può essere facilmente nascosto in dettagli architettonici come travi doghe di legno.

EN The adjustability on the horizontal axis can reach +90°, -90° on request.

IT L'orientabilità sull'asse orizzontale può raggiungere i +90°, -90° su richiesta.

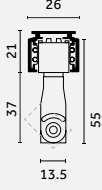
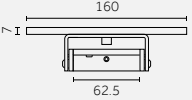
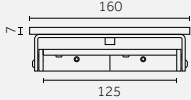
Technical info & codes

	125 mm	250 mm
<p>Incline 48V Dark Performance Adjustable</p> 	 <p>p.80</p>	 <p>p.80</p>
	<p>Narrow (18°) Medium (24°) Medium-wide (35°) Wide (50°)</p>	<p>Narrow (18°) Medium (24°) Medium-wide (35°) Wide (50°)</p>
<p>Light source/ Sorgente luminosa</p>	<p>HIGH POWER LED 7 W 859 lm - 931 lm L80 B10=50,000 h 2700 K; 3000 K; 3500 K SDCM <3 CRI >90 On request: (4000K, CRI>90)</p>	<p>HIGH POWER LED 14 W 1718 lm - 1862 lm L80 B10=50,000 h 2700 K; 3000 K; 3500 K SDCM <3 CRI >90 On request: (4000K, CRI>90)</p>

Dark Performance Adjustable

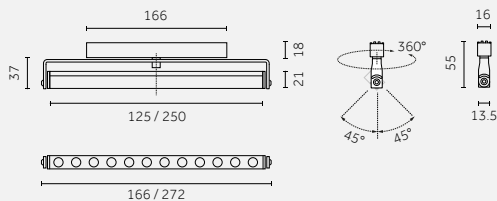

125 mm (6LED)

7 W HIGH POWER LED - 56 W/m

Lumen delivered up to 835 lm / Lumen maintenance: L80 B10=50,000h

Code example:

D . **MS92** **B** . **HW** **31**

Track 48V: p. 108-109 / 112-113

Accessories: p.81

Photometric data:

www.reggiani.net

Driver	Version	Length	Diffuser	Optics	LED	K	CRI	lm	SDCM	Finishes
D DALI	MS92	125 mm	Dark Performance	B 18° Narrow	HW	2700	>90	859	<3	31
				E 24° Medium	HQ	3000	>90	931	<3	
				H 35° Medium-wide	WQ	3500	>90	931	<3	
				M 50° Wide		4000K (CRI >90) on request LED nominal lumen				

250 mm (12LED)

14 W HIGH POWER LED - 56 W/m

Lumen delivered up to 1670 lm / Lumen maintenance: L80 B10=50,000h

Driver	Version	Length	Diffuser	Optics	LED	K	CRI	lm	SDCM	Finishes
D DALI	MS93	250 mm	Dark Performance	B 18° Narrow	HW	2700	>90	1718	<3	31
				E 24° Medium	HQ	3000	>90	1862	<3	
				H 35° Medium-wide	WQ	3500	>90	1862	<3	
				M 50° Wide		4000K (CRI >90) on request LED nominal lumen				



For Track 48V
Recessed, Surface, Surface/Pendant
p. 108-109 / 112-113



For Traceline Track 48V
Surface/Pendant
Pendant Indirect
Deep Pendant Direct / Indirect
visit reggiani.net

Accessories

Incline 48V - Dark Performance Adjustable - 125 mm

Colored filters/ Filtri colorati



Description	Code
Square holder with colored filter/ Holder quadrato con filtro colorato	0.27332.004A
For 6X LED	0.27332.005A
	0.27332.006A
	0.27332.007A
Colour:	0.27332.008A
4A Red 6A Blue 8A Yellow	0.27332.009A
5A Green 7A Pink 9A Orange	



Selective filters/ Filtri selettivi

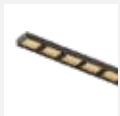

Description	Code
Square holder with 3000K-2700K filter/ Holder con filtro 3000K-2700K	0.27333.0000
For 6X LED	

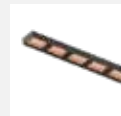

Description	Code
Square holder with 2700K-2000K filter/ Holder con filtro 2700K-2000K	0.27336.0000
For 6X LED	



Description	Code
Square holder with 2700K-2500K filter/ Holder con filtro 2700K-2500K	0.27334.0000
For 6X LED	



Description	Code
Square holder with 3000K-3500K filter/ Holder con filtro 3000K-3500K	0.27337.0000
For 6X LED	



Description	Code
Square holder with 2700K-2200K filter/ Holder con filtro 2700K-2200K	0.27335.0000
For 6X LED	



Description	Code
Square holder with 3000K-4000K filter/ Holder con filtro 3000K-4000K	0.27338.0000
For 6X LED	

Optics accessories/ Accessori ottiche



Description	Code
Snoot with opal filter/ Cilindro anti-abbaglio con filtro opale	0.27331.0021
For 6X LED	



Description	Code
Square holder with opal lens/ Holder con lente opale	0.27340.0000
For 6X LED	



Description	Code
Snoot/ Cilindro anti-abbaglio	0.27328.0021
For 6X LED	



Description	Code
Square holder with spread lens/ Holder con lente prismatica	0.27341.0000
For 6X LED	



Description	Code
Square holder with elliptical lens/ Holder con filtro ellittico rigato	0.27339.0000
For 6X LED	



Description	Code
Square holder with honeycomb/ Holder con griglia alveolare	0.27329.0000
For 6X LED	

Decorative accessories/ Accessori decorativi



Description	Code
Decorative frosted attachment/ Accessorio decorativo opaco	0.27342.0000
For 6X LED	

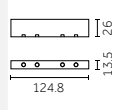

Incline 48V Wall Washer

EN Incline 48V Wall Washer provides soft and uniform wall washer lighting. The dedicated lens system ensures that light intensity is evenly distributed along the entire wall. Available for both standard and Deep 48V tracks.

IT Incline 48V Wall Washer garantisce un'illuminazione wall washer morbida ed uniforme. Il sistema di lenti dedicato assicura che l'intensità luminosa venga distribuita uniformemente lungo tutta la parete. Disponibile sia per binari 48V standard che Deep.

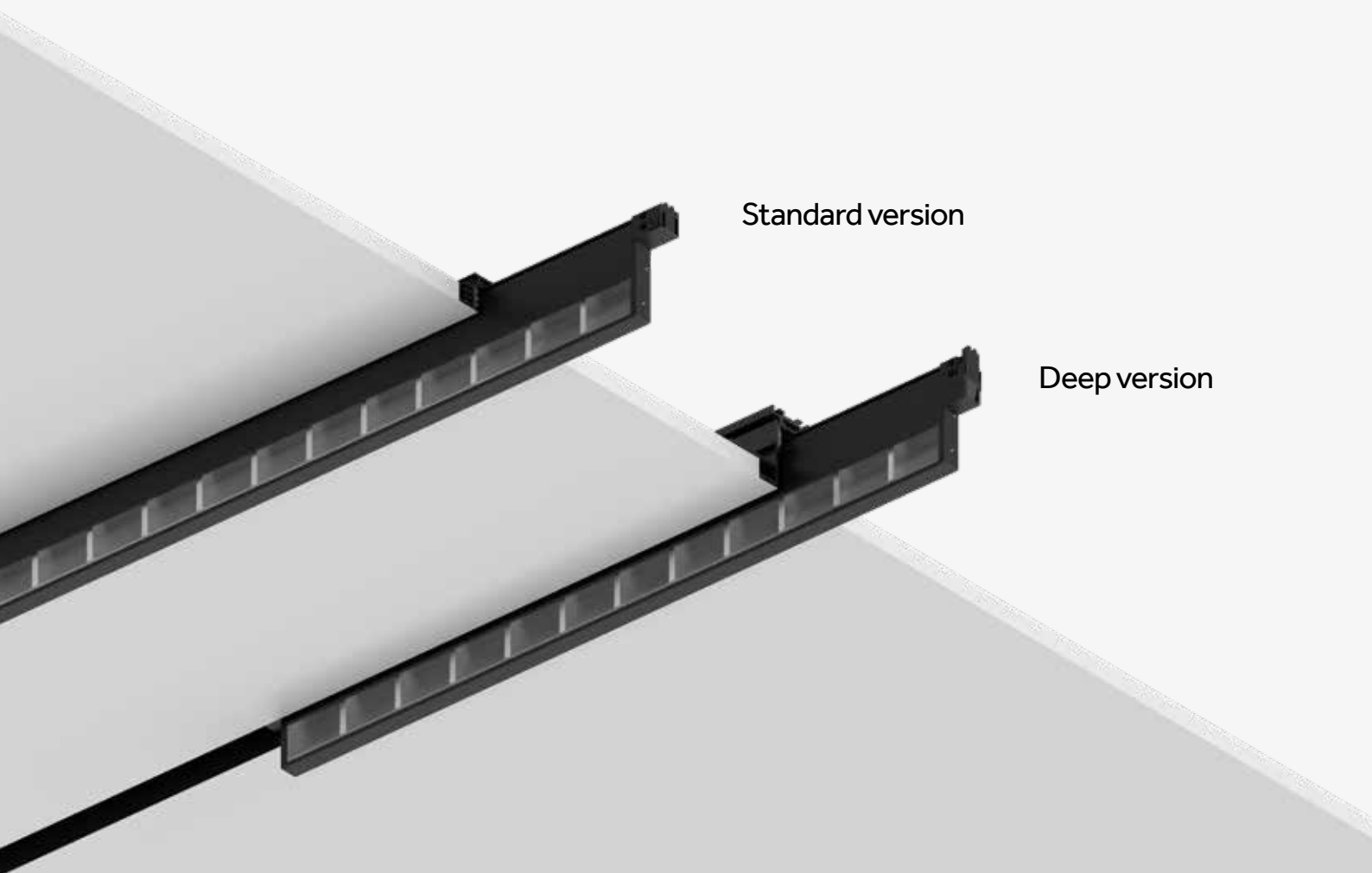

Standard version

Deep version



Incline 48V Wall Washer

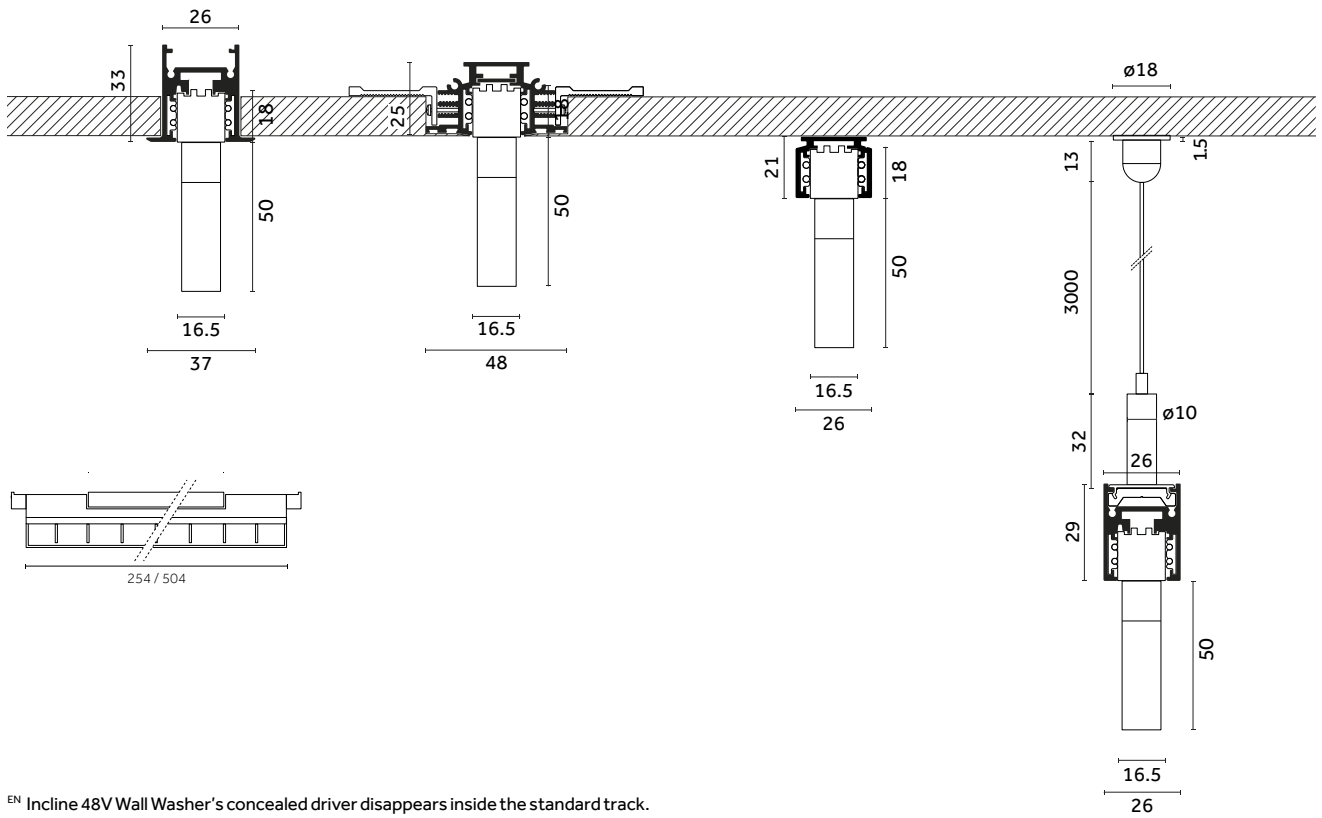

^{EN} Incline 48V Wall Washer's concealed driver disappears inside the standard track.

^{IT} Il driver arretrato di Incline 48V Wall Washer, scompare all'interno dei binari standard.

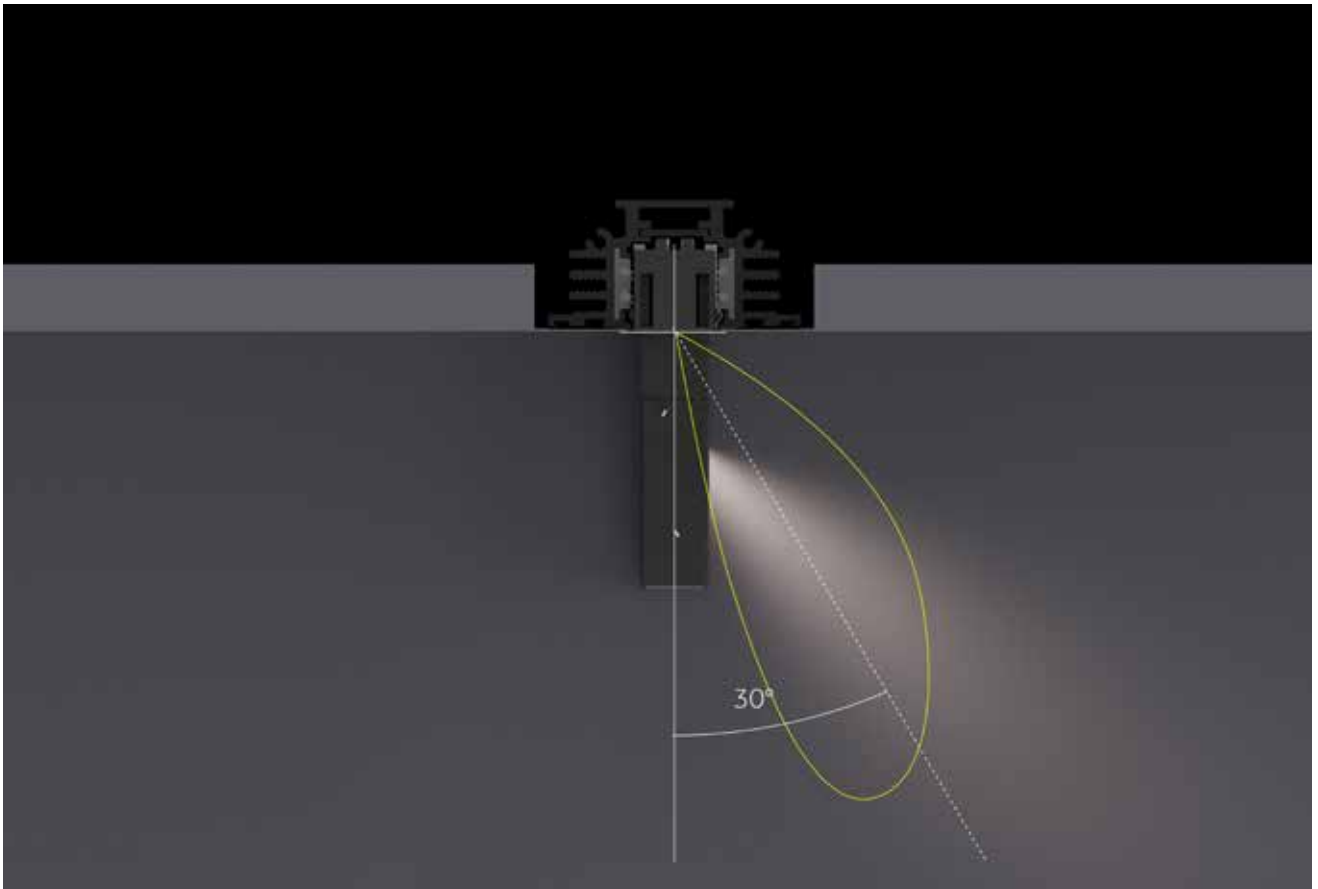

^{EN} The 30° Wall Washer beam angle of Incline 48V Wall Washer guarantees an even distribution of light.

^{IT} Il fascio di 30° Wall Washer di Incline 48V Wall Washer garantisce una distribuzione omogenea della luce.

Incline 48V Wall Washer - Deep

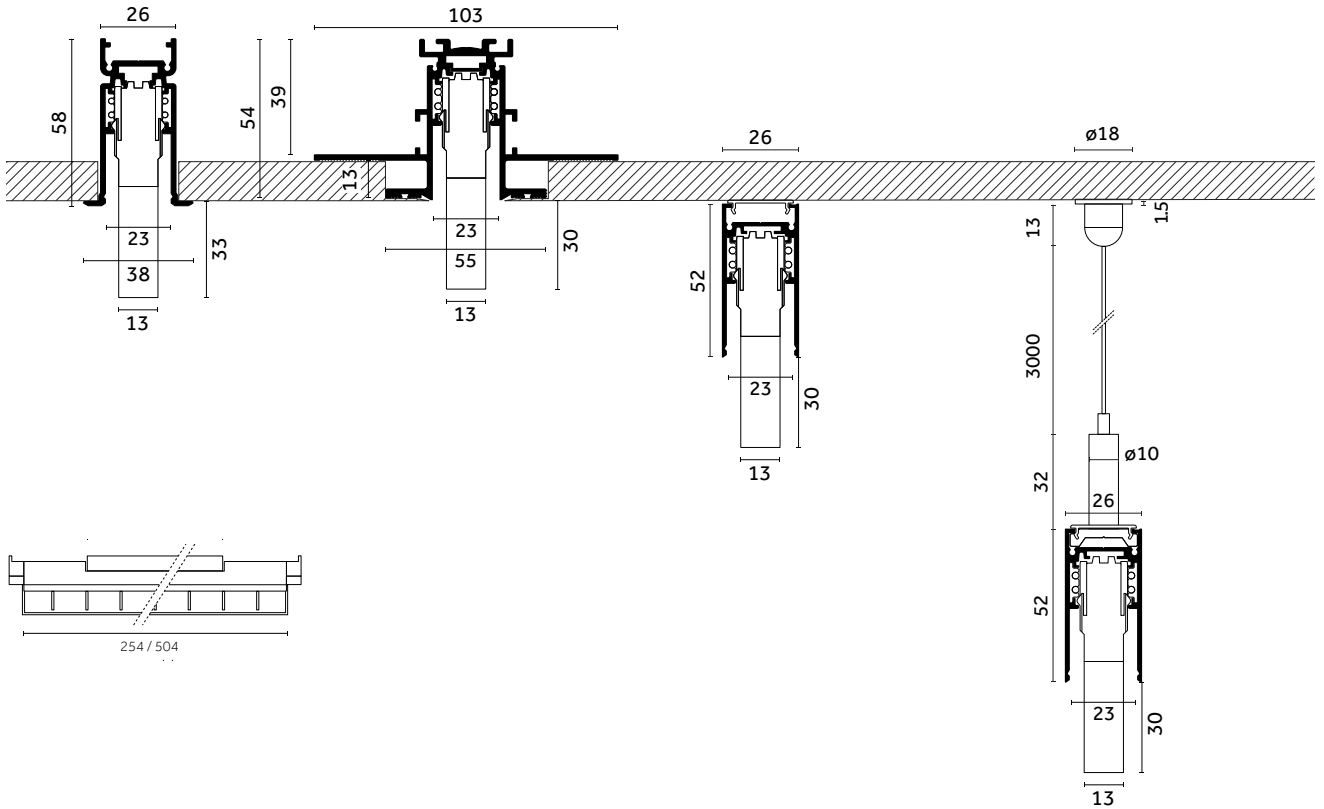

EN Incline 48V Wall Washer - Deep's concealed driver disappears inside the deep track.

IT Il driver arretrato di Incline 48V Wall Washer - Deep, scompare all'interno dei binari deep.

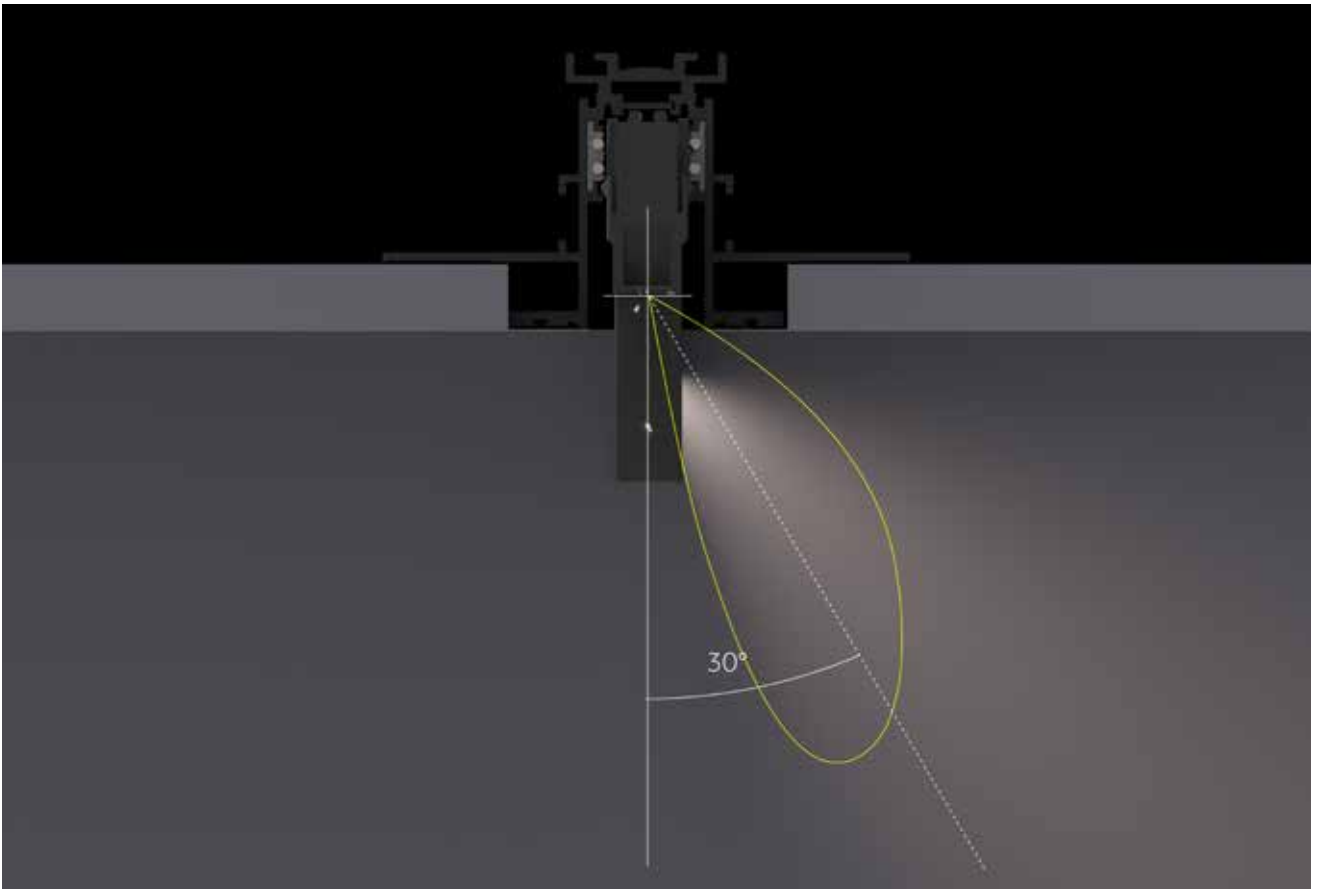

EN The 30° Wall Washer beam angle of Incline 48V Wall Washer Deep guarantees an even distribution of light.

IT Il fascio di 30° Wall Washer di Incline 48V Wall Washer Deep garantisce una distribuzione omogenea della luce.





^{EN} Flexible configuration thanks to the possibility to install multiple Incline 48V Wall Washer alternately along the track.

^{IT} Configurazione flessibile grazie alla possibilità di installare Incline 48V Wall Washer in maniera alternata lungo il binario.

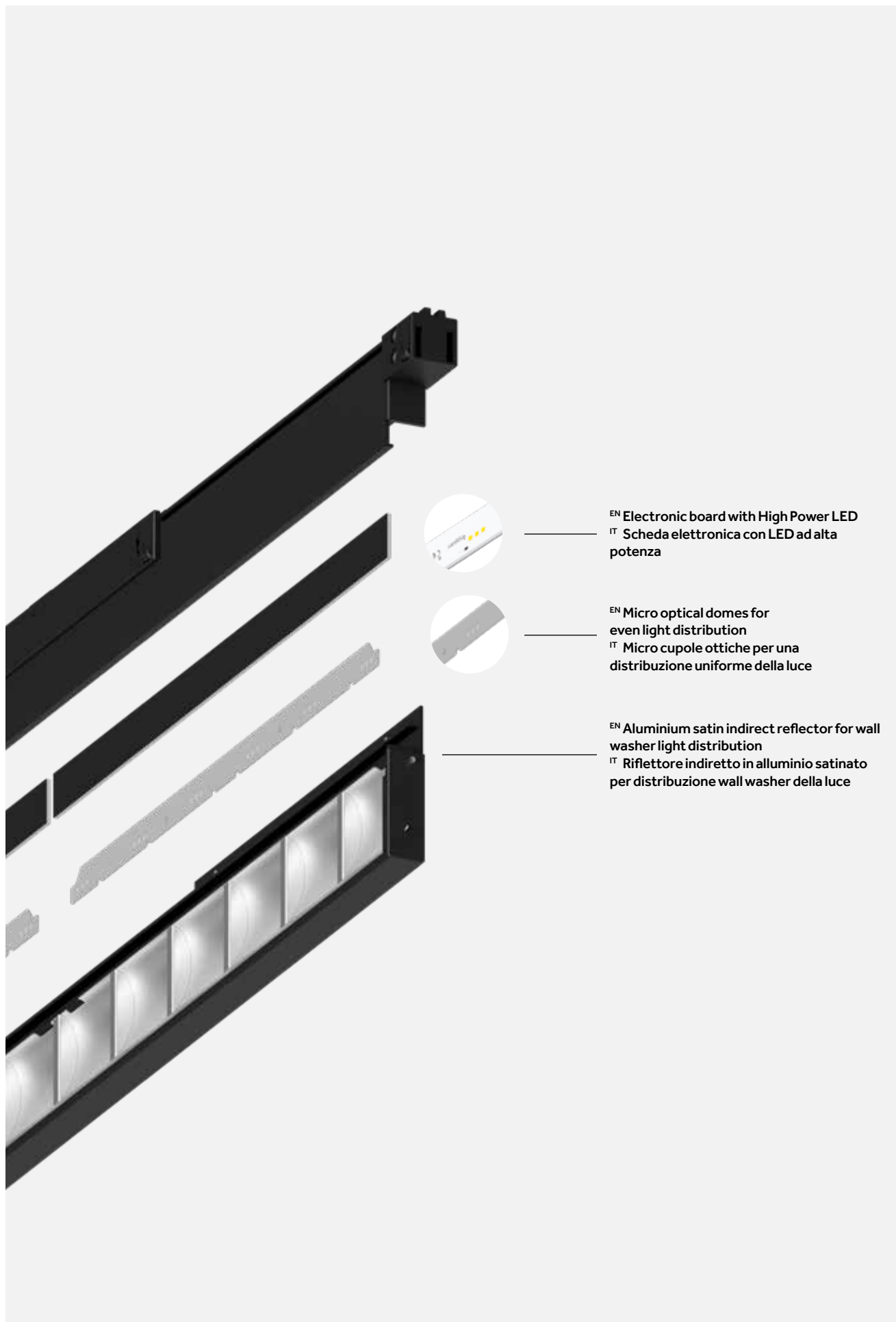

^{EN} Electronic board with High Power LED
^{IT} Scheda elettronica con LED ad alta potenza

^{EN} Micro optical domes for even light distribution
^{IT} Micro cupole ottiche per una distribuzione uniforme della luce

^{EN} Aluminium satin indirect reflector for wall washer light distribution
^{IT} Riflettore indiretto in alluminio satinato per distribuzione wall washer della luce

EN
IT

Wall washing installation example (3m) Esempio di installazione effetto wall washer (3m)



Incline 48V

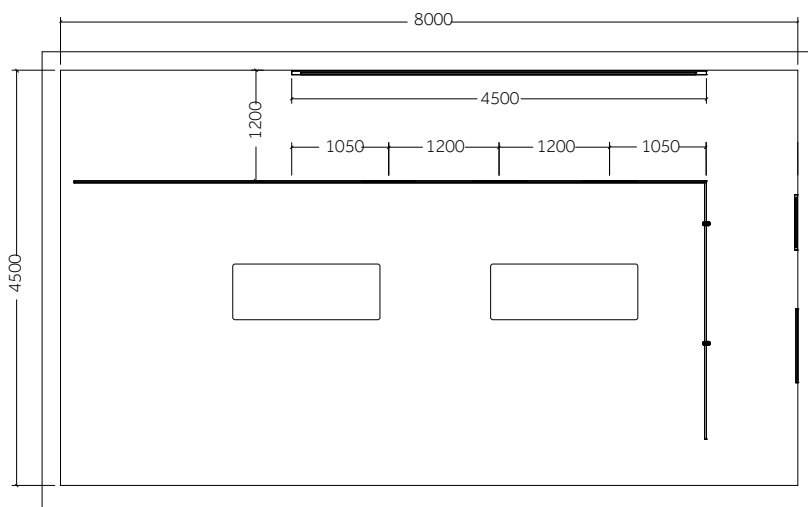

Products: Incline 48V Wall Washer - 500mm, 24W, 3000K
Center distance: 1200mm
Average illuminance: >535lx

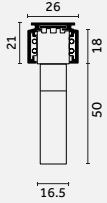
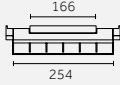
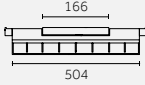
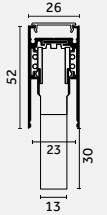
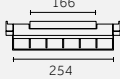
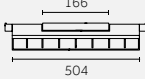

Technical info & codes

	250mm	500mm
<p>Incline 48V Wall Washer</p> 	 <p>p.94</p>	 <p>p.94</p>
<p>Incline 48V Wall Washer Deep</p> 	 <p>p.95</p>	 <p>p.95</p>
	<p>114°</p>	<p>114°</p>
<p>Light source/ Sorgente luminosa</p>	<p>HIGH POWER LED 12 W 1642 lm - 1779 lm L80 B20=50,000h 2700 K, 3000 K, 3500 K CRI >90 SDCM <3 On request: (4000K, CRI>90)</p>	<p>HIGH POWER LED 24 W 3284 lm - 3558 lm L80 B20=50,000h 2700 K, 3000 K, 3500 K CRI >90 SDCM <3 On request: (4000K, CRI>90)</p>

Wall Washer

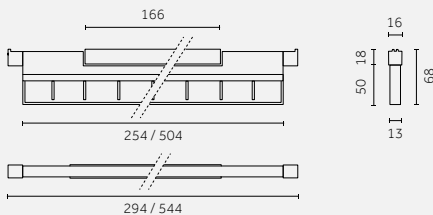
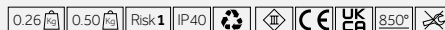

Code example:

D . **NS93** **H** . **HW** **12**

Track 48V: p. 108-109 / 112-113

Photometric data:
www.reggiani.net

250 mm

12 W HIGH POWER LED - 35 W/m Lumen delivered up to 1346 lm / Lumen maintenance: L80 B20=50,000h

Driver	Version	Length	Diffuser	LED	K	CRI	lm	SDCM	Finishes
D DALI	NS93	250 mm	H Wall Washer	HW	2700	>90	1642	<3	12
				HQ	3000	>90	1779	<3	31
				WQ	3500	>90	1779	<3	

4000K (CRI >90) on request
LED nominal lumen

500 mm

24 W HIGH POWER LED - 49 W/m Lumen delivered up to 2693 lm / Lumen maintenance: L80 B10=50,000h

Driver	Version	Length	Diffuser	LED	K	CRI	lm	SDCM	Finishes
D DALI	NS94	500 mm	H Wall Washer	HW	2700	>90	3284	<3	12
				HQ	3000	>90	3558	<3	31
				WQ	3500	>90	3558	<3	

4000K (CRI >90) on request
LED nominal lumen



For Track 48V
Recessed, Surface, Surface/Pendant
p. 108-109 / 112-113



For Traceline Track 48V
Surface/Pendant
Pendant Indirect
Deep Pendant Direct / Indirect
visit reggiani.net

Wall Washer - Deep

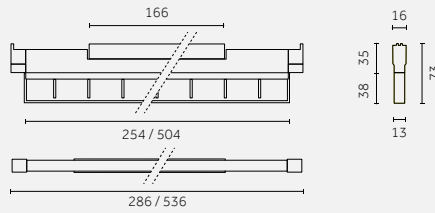

Code example:

D . NQ93 H . HW 12

Track 48V: p. 110-111 / 114-115
 Photometric data:
www.reggiani.net

250 mm

12 W HIGH POWER LED - 35 W/m Lumen delivered up to 1346 lm / Lumen maintenance: L80 B20=50,000h

Driver	Version	Length	Diffuser	LED	K	CRI	lm	SDCM	Finishes
D DALI	NQ93	250 mm	H Wall Washer	HW	2700	>90	1642	<3	12
				HQ	3000	>90	1779	<3	31
				WQ	3500	>90	1779	<3	

4000K (CRI >90) on request
 LED nominal lumen

500 mm

24 W HIGH POWER LED - 00 W/m Lumen delivered up to 2693 lm / Lumen maintenance: L80 B10=50,000h

Driver	Version	Length	Diffuser	LED	K	CRI	lm	SDCM	Finishes
D DALI	NQ94	500 mm	H Wall Washer	HW	2700	>90	3284	<3	12
				HQ	3000	>90	3558	<3	31
				WQ	3500	>90	3558	<3	

4000K (CRI >90) on request
 LED nominal lumen



For Track 48V - Deep
 Recessed, Surface, Surface/Pendant
 p. 110-111 / 114-115

Play with the

48V system

Incline 48V

EN Create your own configuration by combining Incline 48V with Yori Evo 48V spotlights and Yori Pendant 48V suspension fixtures to create a customized lighting result. The 48V system is now complete: choose between standard and Deep tracks and compose your setting.

IT Crea la tua configurazione, combinando Incline 48V con i proiettori Yori Evo 48V e le sospensioni Yori Pendant 48V, in modo da creare un risultato illuminotecnico personalizzato. Il sistema 48V è ora completo: scegli tra binari standard e Deep e componi il tuo setting.



Standard track configuration:



EN Incline 48V
IT Incline 48V



EN Yori Evo 48V
IT Yori Evo 48V



EN Yori Pendant 48V
IT Yori Pendant 48V

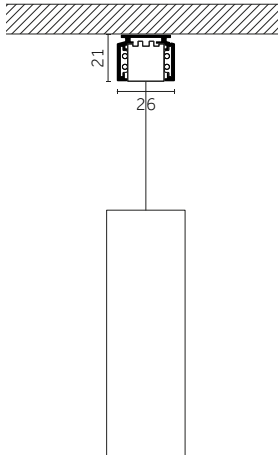
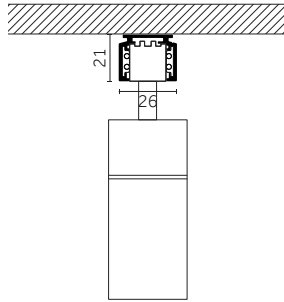
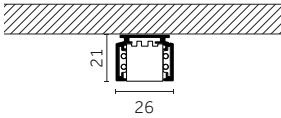

Deep track configuration:



EN Incline 48V Deep
IT Incline 48V Deep



EN Yori Evo 48V - long arm
IT Yori Evo 48V - long arm



EN Yori Pendant 48V
IT Yori Pendant 48V



EN Yori Linear 48V
IT Yori Linear 48V

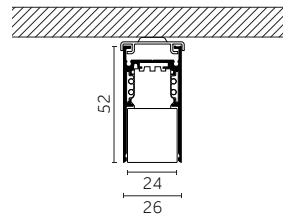
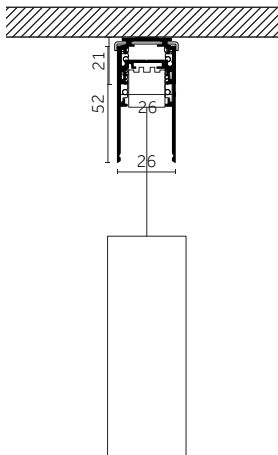
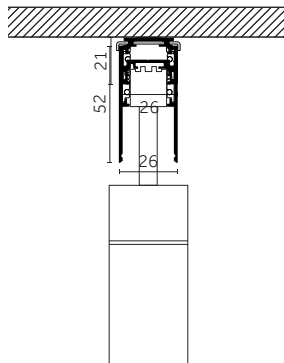
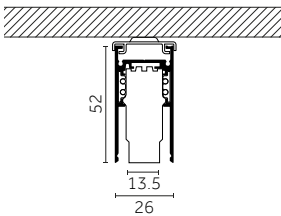

48V Standard track product families

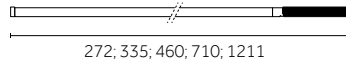
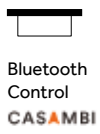

Incline 48V Dark Performance (UGR<19)

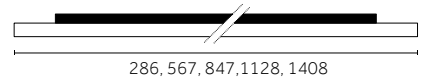

Yori Linear 48V

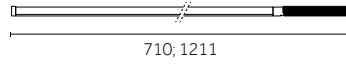

Incline 48V Opal

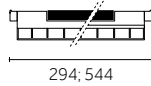

Incline 48V Wall Washer

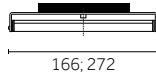

Incline 48V Dark Performance Adjustable

Incline 48V

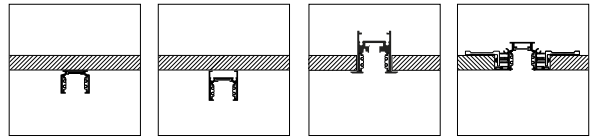

Track 48V - Surface Slim

Track 48V - Surface/Pendant

Track 48V - Recessed Trim

Track 48V - Recessed Trimless

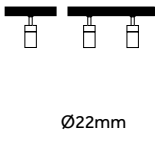

Ø22mm

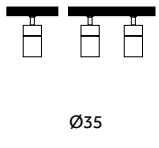

Ø35

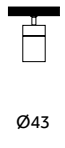

Ø43

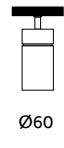

Ø60

Yori Evo 48V

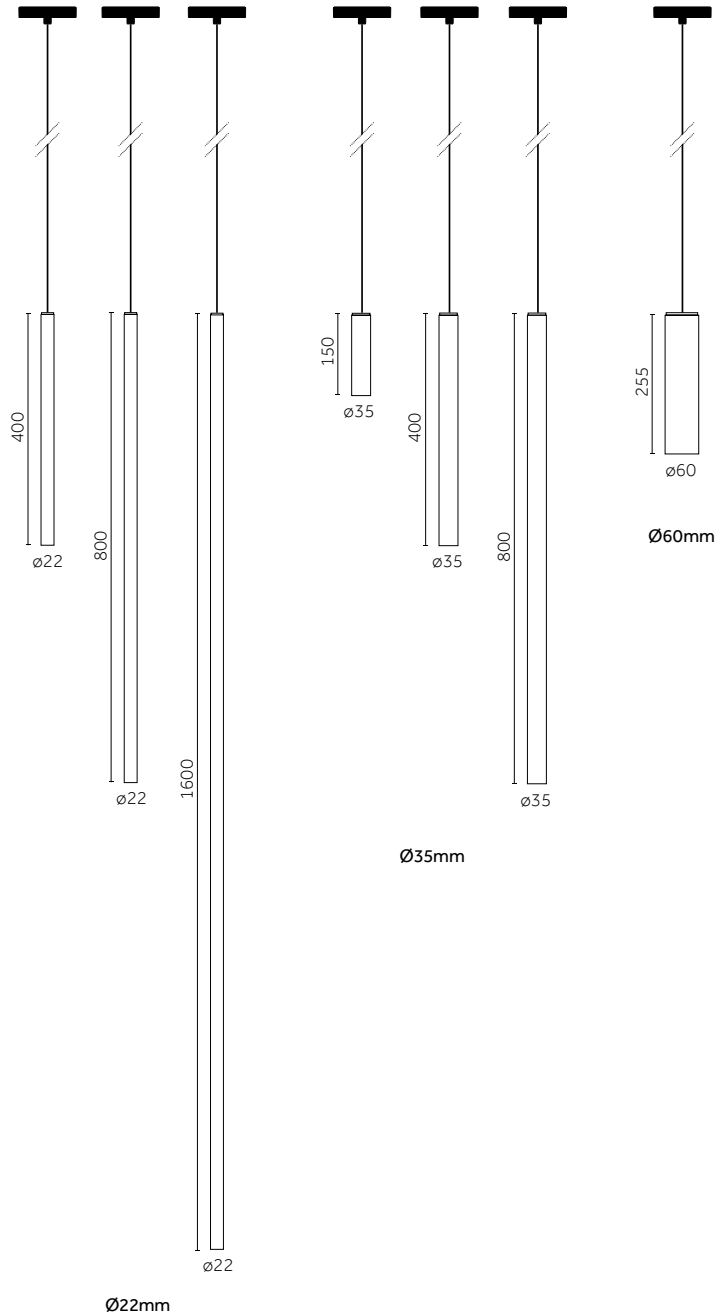

Yori Evo 48V Pendant

48V Deep Track product families

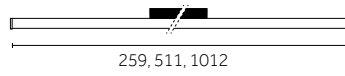

Incline 48V Dark Performance (UGR<15) - Deep

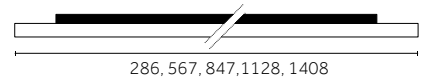

Yori Linear 48V

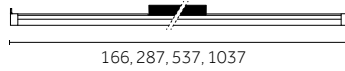

Incline 48V Dark Performance (UGR<19) - Deep

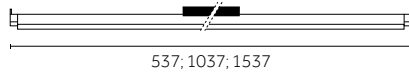

Incline 48V Opal - Deep, Deep (Drop)

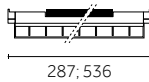

Incline 48V Wall Washer - Deep

Incline 48V

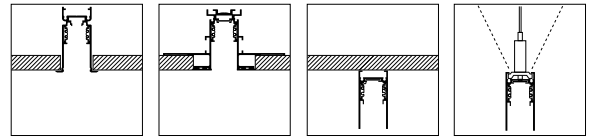

Track 48V -
Deep Recessed
Trim

Track 48V -
Deep Recessed
Trimless

Track 48V -
Deep Surface/
Pendant

Track 48V -
Deep Pendant/
Indirect

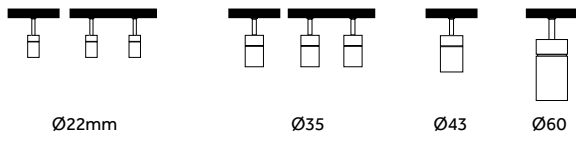

Yori Evo 48V Long Arm

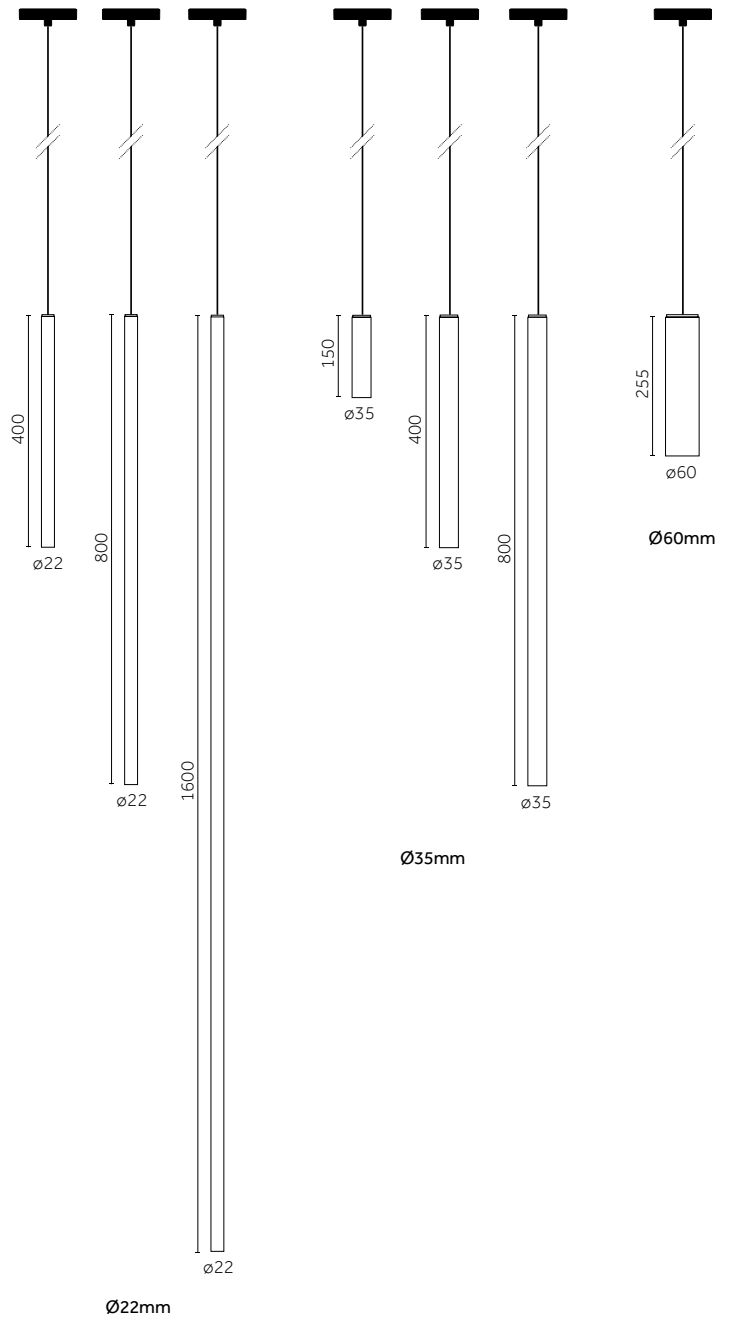

Yori Evo 48V Pendant

Track 48V

Incline 48V

Low voltage Track 48V Recessed

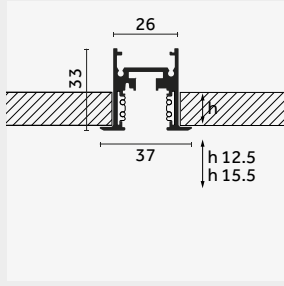

Track 48V Recessed Trim p. 108

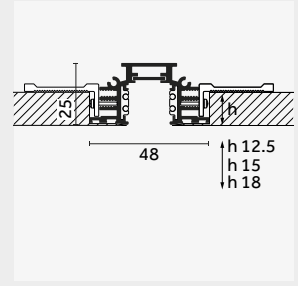

Track 48V Recessed Trimless p. 109

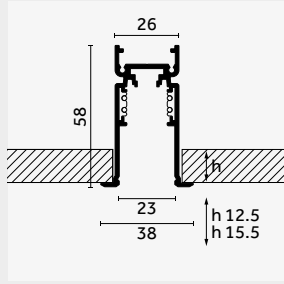

Track 48V - Deep Recessed Trim p. 110

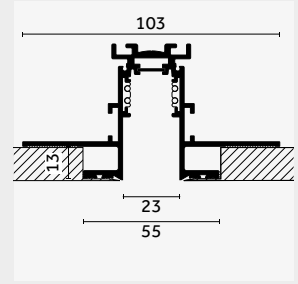

Track 48V - Deep Recessed Trimless p. 111

Low voltage Track 48V Surface/Pendant

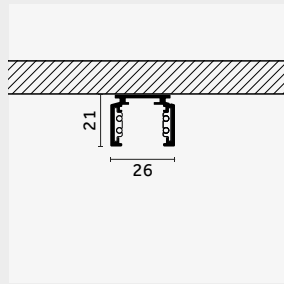

Track 48V Surface Slim p. 112

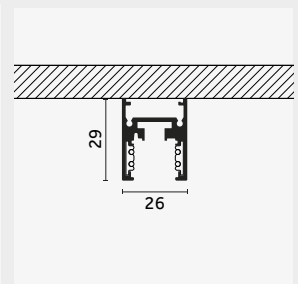

Track 48V Surface/Pendant p. 113

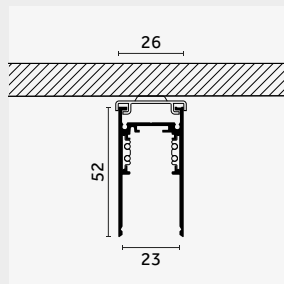

Track 48V Deep Surface/Pendant p. 114

Low voltage Track 48V Pendant - Indirect

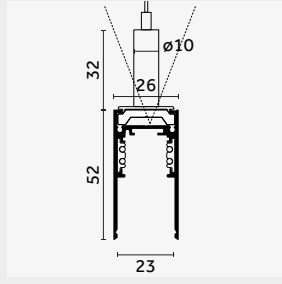

Track 48V Deep
Pendant

p. 115

Not enough? Discover Traceline 48V

Traceline Track 48V



Traceline Track 48V
Surface/Pendant



Traceline Track 48V
Pendant Indirect



Traceline Track 48V
Deep Pendant Direct / Indirect



Scan the QR code and
discover Traceline 48V

Track 48V - Recessed Trim

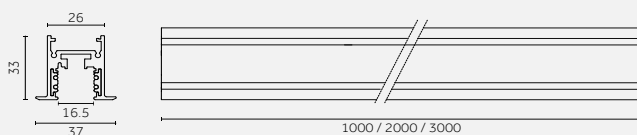
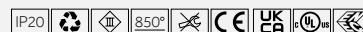

Code example:
0.02401.00 12

Version	Length mm	Weight kg	Finishes
0.02401.00	1000	1,00	12 <input type="checkbox"/>
0.02402.00	2000	2,00	31 <input type="checkbox"/>
0.02403.00	3000	3,00	<input type="checkbox"/>

Remote driver: p.118
Control systems: p.119
Electromechanical connections: p.119

Track 48V - Recessed Trim - Accessories

Accessories/ Accessori

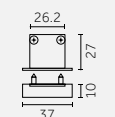
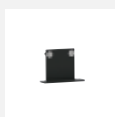

Description
End cap for tracks/
Tappo di chiusura per binari

Code
0.02481.00

Finishes
12
31

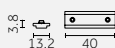

Description
Reinforcing bracket for jointing connection/
Staffa di rinforzo per installazioni in linea continua

Code
0.02487.00

Finishes
21

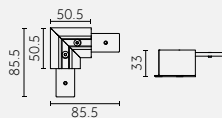

Description
90° ceiling corner/
Angolo a 90° a soffitto

Code
0.02414.00

Finishes
12
31

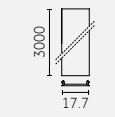

Description
Aesthetic track cover/
Cover di chiusura estetica

Code
0.02425.00

Finishes
10
21

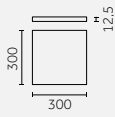

Description
Trimless inspection hatch/
Botola d'ispezione Trimless

Code
0.40020.0000



Description
Cable cutter/
Tronchese per taglio conduttori del binario

Code
0.02064.0000

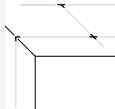

Description
L- connector for wall/ceiling corners, T / X connectors for ceilings/
Giunto a "L" per angoli parete/soffitto, giunti a "T"/"X" per soffitto

On request

Track 48V - Recessed Trimless

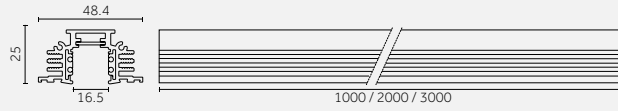

Code example:
0.02465.00 21

Remote driver: p.118
Control systems: p.119
Electromechanical connections: p.119

Version	Length mm	Weight kg	Finishes
0.02465.00	1000	1,00	21
0.02466.00	2000	2,00	
0.02467.00	3000	3,00	

Track 48V - Recessed Trimless - Accessories

Accessories/ Accessori

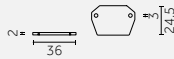

Description
End cap for tracks/
Tappo di chiusura per binario

Code
0.02468.00

Finishes
21

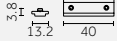

Description
Reinforcing bracket for jointing connection/
Staffa di rinforzo per installazioni in linea continua

Code
0.02487.00

Finishes
21

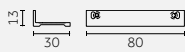

Description
Bracket for trimless installation (For 1000 mm order 4 pieces) /
Staffa per applicazioni Trimless (Per 1000 mm ordinare 4 pezzi)

Code
0.02475.0000

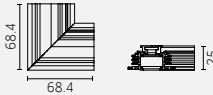

Description
90° ceiling corner/
Angolo a 90° a soffitto

Code
0.02474.00

Finishes
21

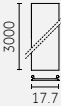

Description
Aesthetic track cover/
Cover di chiusura estetica

Code
0.02425.00

Finishes
10
21

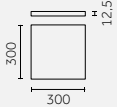

Description
Trimless inspection hatch/
Botola d'ispezione Trimless

Code
0.40020.0000



Description
Cable cutter/
Tronchese per taglio conduttori del binario

Code
0.02064.0000

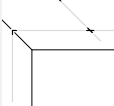

Description
L- connector for wall/ceiling corners, T / X connectors for ceilings/
Giunto a "L" per angoli parete/soffitto, giunti a "T"/"X" per soffitto

On request

Track 48V - Deep Recessed Trim

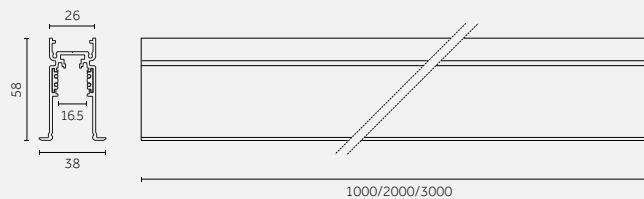

Code example:
0.02590.00 12

Version	Length mm	Weight kg	Finishes
0.02590.00	1000	1,00	12 <input type="checkbox"/>
0.02591.00	2000	2,00	31 <input type="checkbox"/>
0.02592.00	3000	3,00	<input type="checkbox"/>

Remote driver: p.118
Control systems: p.119
Electromechanical connections: p.119

Track 48V - Deep Recessed Trim - Accessories

Accessories/ Accessori

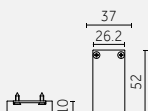

Description
End cap for tracks/
Tappo di chiusura per binari

Code
0.02593.00

Finishes
12
31

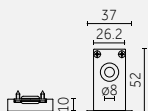

Description
End cap with cable hole/
Tappo di chiusura con foro per cavo

Code
0.02594.00

Finishes
12
31



Description
Reinforcing bracket for jointing connection/
Staffa di rinforzo per installazioni in linea continua

Code
0.02487.00

Finishes
21

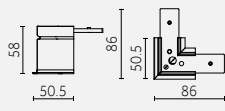

Description
90° ceiling corner/
Angolo a 90° a soffitto

Code
0.02595.00

Finishes
12
31

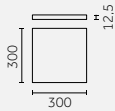

Description
Trimless inspection hatch/
Botola d'ispezione Trimless

Code
0.40020.0000



Description
Cable cutter/
Tronchese per taglio conduttori del binario

Code
0.02064.0000

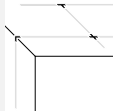

Description
L- connector for wall/ceiling corners, T / X connectors for ceilings/
Giunto a "L" per angoli parete/soffitto, giunti a "T"/"X" per soffitto

On request

Track 48V - Deep Recessed Trimless

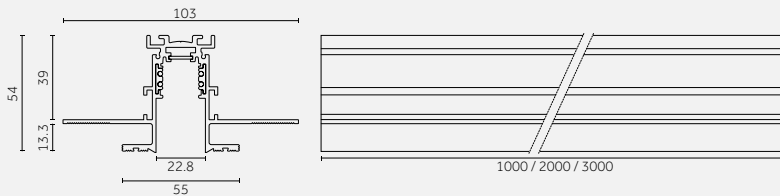

Code example:
0.02445.00 21

Version	Length mm	Weight kg	Finishes
0.02445.00	1000	1,00	21
0.02446.00	2000	2,00	
0.02447.00	3000	3,00	

Remote driver: p.118
Control systems: p.119
Electromechanical connections: p.119

Track 48V - Deep Recessed Trimless - Accessories

Accessories/ Accessori

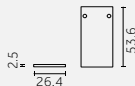

Description
End cap for track/
Tappo di chiusura per binario

Code
0.02463.00

Finishes
12
31

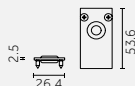

Description
End cap with cable hole/
Tappo di chiusura con foro per cavo

Code
0.02464.00

Finishes
12
31

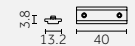

Description
Reinforcing bracket for jointing connection/
Staffa di rinforzo per installazioni in linea continua

Code
0.02487.00

Finishes
21

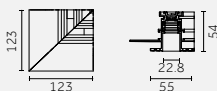

Description
90° ceiling corner /
Angolo a 90° a soffitto

Code
0.02478.00

Finishes
21

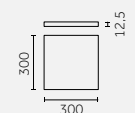

Description
Trimless inspection hatch/
Botola d'ispezione Trimless

Code
0.40020.0000

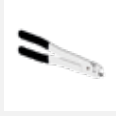

Description
Cable cutter/
Tronchese per taglio conduttori del binario

Code
0.02064.0000

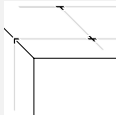

Description
L- connector for wall/ceiling corners, T / X connectors for ceilings/
Giunto a "L" per angoli parete/soffitto, giunti a "T"/"X" per soffitto

On request

Track 48V - Surface Slim

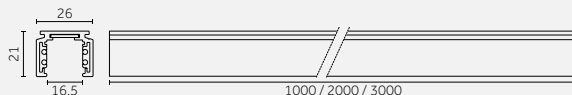
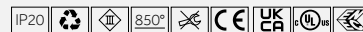

Code example:

0.02450.00 12

Remote driver: p.118

In-Track driver: p.118

Control systems: p.119

Electromechanical connections: p.119

Version	Length mm	Weight kg	Finishes	Euro
0.02450.00	1000	0,70	12 <input type="checkbox"/>	124,00
0.02451.00	2000	1,40	31 <input type="checkbox"/>	242,00
0.02452.00	3000	2,10		359,00

Track 48V - Surface Slim - Accessories

Accessories/ Accessori

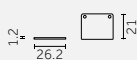
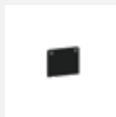

Description

End cap/
Tappo di chiusura

Code

0.02453.00

Finishes

12
31

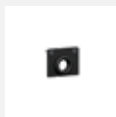

Description

End cap with cable hole/
Tappo di chiusura con foro per cavo

Code

0.02454.00

Finishes

12
31

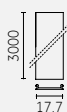

Description

Aesthetic track cover/
Cover di chiusura estetica

Code

0.02425.00

Finishes

10
21



Description

Cable cutter/
Tronchese per taglio conduttori del binario

Code

0.02064.0000

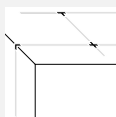

Description

L- connector for wall/ceiling corners, T / X connectors for ceilings/
Giunto a "L" per angoli parete/soffitto, giunti a "T"/"X" per soffitto

On request

Track 48V - Surface/Pendant

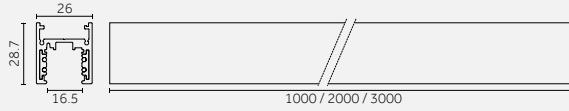

Code example:
0.02455.00 12

Remote driver: p.118
In-Track driver: p.118
Control systems: p.119
Electromechanical connections: p.119

Version	Length mm	Weight kg	Finishes	Euro
0.02455.00	1000	0,77	12	124,00
0.02456.00	2000	1,54	31	248,00
0.02457.00	3000	2,31		399,00

Notes:
Kit for suspended application to be ordered separately p.116-117/ Kit per l'applicazione a sospensione da ordinare separatamente vedi p.116-117

Track 48V - Surface/Pendant - Accessories

Accessories/ Accessori

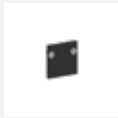

Description
End cap/
Tappo di chiusura

Code
0.02458.00

Finishes
12
31

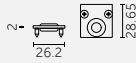
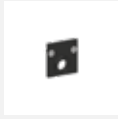

Description
End cap with cable hole/
Tappo di chiusura con foro per cavo

Code
0.02459.00

Finishes
12
31

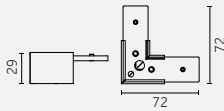

Description
90° corner/
Angolo a 90°

Code
0.02449.00

Finishes
12
31

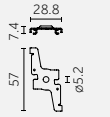

Description
Bracket for surface-mounting/
Clip per fissaggio a superficie

Code
0.02415.00

Finishes
10
21

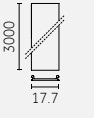

Description
Aesthetic track cover/
Cover di chiusura estetica

Code
0.02425.00

Finishes
10
21



Description
Cable cutter/
Tronchese per taglio conduttori del binario

Code
0.02064.0000

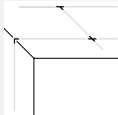

Description
L- connector for wall/ceiling corners, T / X connectors for ceilings/
Giunto a "L" per angoli parete/soffitto, giunti a "T"/"X" per soffitto

On request

Track 48V - Deep Surface/Pendant

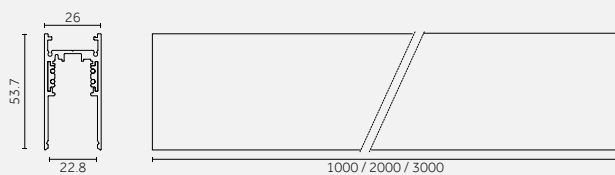
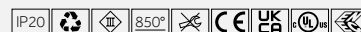

Code example:

0.02460.00 12

Remote driver: p.118
 In-Track driver: p.118
 Control systems: p.119
 Electromechanical connections: p.119

Version	Length mm	Weight kg	Finishes
0.02460.00	1000	0,95	12 <input type="checkbox"/>
0.02461.00	2000	1,90	31 <input type="checkbox"/>
0.02462.00	3000	2,85	12 <input type="checkbox"/>

Notes:

Kit for suspended application to be ordered separately
 p.116-117/ Kit per l'applicazione a sospensione da ordinare separatamente vedi p.116-117

Track 48V - Deep Surface/Pendant - Accessories

**Accessories/
 Accessori**

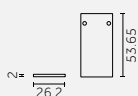

Description
 End cap for track/
 Tappo di chiusura per binario

Code
0.02463.00

Finishes
12
31

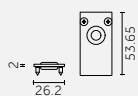

Description
 End cap with cable hole/
 Tappo di chiusura con foro per cavo

Code
0.02464.00

Finishes
12
31

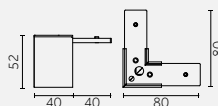

Description
 90° corner/
 Angolo a 90°

Code
0.02448.00

Finishes
12
31



Description
 Bracket for surface-mounting/
 Clip per fissaggio a superficie

Code
0.02415.00

Finishes
10
21

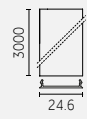

Description
 Aesthetic track cover/
 Cover di chiusura estetica

Code
0.02424.00

Finishes
10
21



Description
 Cable cutter/
 Tronchese per taglio conduttori del binario

Code
0.02064.0000

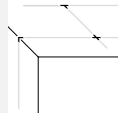

Description
 L- connector for wall/ceiling corners, T / X connectors for ceilings/
 Giunto a "L" per angoli parete/soffitto, giunti a "T"/"X" per soffitto

On request

Track 48V Deep / Pendant - Indirect

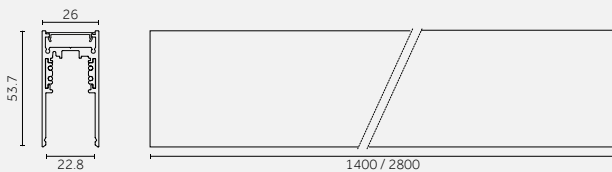

Code example:

X - 02405 - HW 12

Remote driver: p.118

In-Track driver: p.118

Control systems: p.119

Electromechanical connections: p.119

Notes:

Kit for suspended application to be ordered separately p.116-117/ Kit per l'applicazione a sospensione da ordinare separatamente vedi p.116-117

20,2 W MID POWER LED Lumen delivered up to 2430 lm / Lumen maintenance: L90 B5=50,000h

Driver	Version	Length mm	Diffuser	Beam width	LED	K	CRI	lm	SDCM	Finishes
X Not included	02405 On/Off*	1400	Opal	105°	HW	2700	>90	2520	<3	12 <input type="checkbox"/>
	V2405 Dimm 1-10V*				HQ	3000	>90	3050	<3	31 <input type="checkbox"/>
	D2405 DALI				HN	4000	>90	3300	<3	<input type="checkbox"/>

LED nominal lumen

39,4 W MID POWER LED Lumen delivered up to 4860 lm / Lumen maintenance: L90 B5=50,000h

Driver	Version	Length mm	Diffuser	Beam width	LED	K	CRI	lm	SDCM	Finishes
X Not included	02406 On/Off*	2800	Opal	105°	HW	2700	>90	5040	<3	12 <input type="checkbox"/>
	V2406 Dimm 1-10V*				HQ	3000	>90	6100	<3	31 <input type="checkbox"/>
	D2406 DALI				HN	4000	>90	6600	<3	<input type="checkbox"/>

LED nominal lumen

*Version with separate switching indirect light and track, available on request/*Versione per accensione separata luce indiretta/binario, disponibile su richiesta.

Track 48V Deep / Pendant - Indirect (Tunable white)

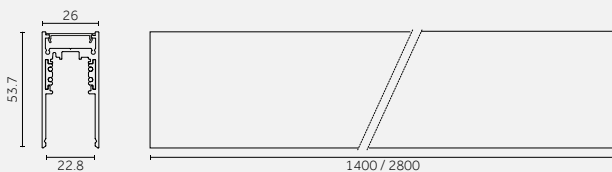
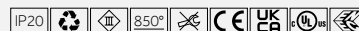

Code example:

T - 02405 - WT 12

Remote driver: p.118

In-Track driver: p.118

Control systems: p.119

Electromechanical connections: p.119

Notes:

Kit for suspended application to be ordered separately p.116-117/ Kit per l'applicazione a sospensione da ordinare separatamente vedi p.116-117

20 W MID POWER LED

Driver	Version	Length mm	Diffuser	Beamwidth	LED	K	CRI	lm	SDCM	Finishes
X Not included	T2405	1400	Opal	105°	WT	2200-6500	>80	2800	<3	12 <input type="checkbox"/>
					QT	2200-6500	>90	2310	<3	31 <input type="checkbox"/>

LED nominal lumen

40 W MID POWER LED

Driver	Version	Length mm	Diffuser	Beamwidth	LED	K	CRI	lm	SDCM	Finishes
X Not included	T2406	2800	Opal	105°	WT	2200-6500	>90	5600	<3	12 <input type="checkbox"/>
					QT	2200-6500	>90	4670	<3	31 <input type="checkbox"/>

LED nominal lumen

Track 48V Deep / Pendant - Indirect - Accessories

Accessories/ Accessori

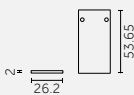

Description
End cap for track/
Tappo di chiusura per binario

Code
0.02463.00

Finishes
12
31

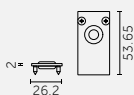

Description
End cap with cable hole/
Tappo di chiusura con foro per cavo

Code
0.02464.00

Finishes
12
31

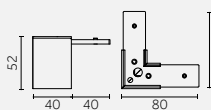

Description
90° corner/
Angolo a 90°

Code
0.02449.00

Finishes
12
31



Description
Aesthetic track cover/
Cover di chiusura estetica

Code
0.02424.00

Finishes
10
21

**Pendant mounting (surface-mounted track)/
Fissaggio a sospensione (binario da superficie)**

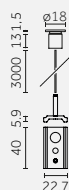

Description

Wire suspension set with 3000mm cable + cylinder ceiling rose + short bracket with gripper for rapid cable Ø 1,5m installation /
Set sospensione con cavo 3000mm + rosone cilindrico + staffa corta con tenditore per fissaggio rapido del cavo Ø 1,5m

Code

0.02407.0000

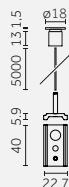
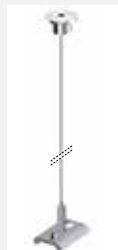

Description

Wire suspension set with 5000mm cable + cylinder ceiling rose + short bracket with gripper for rapid cable Ø 1,5m installation /
Set sospensione con cavo 5000mm + rosone cilindrico + staffa corta con tenditore per fissaggio rapido del cavo Ø 1,5m

Code

0.02408.0000

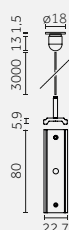

Description

Wire suspension set with 3000mm cable + ceiling rose + long bracket with gripper for rapid cable Ø 1,5m installation /
Set sospensione con cavo 3000mm + rosone + staffa lunga con tenditore per fissaggio rapido del cavo Ø 1,5m

Code

0.02409.0000

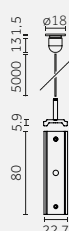

Description

Wire suspension set with 5000mm cable + ceiling rose + long bracket with gripper for rapid cable Ø 1,5m installation /
Set sospensione con cavo 5000mm + rosone + staffa lunga con tenditore per fissaggio rapido del cavo Ø 1,5m

Code

0.02410.0000

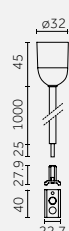

Description

Suspension kit with 1m tige.
Ceiling bracket, plastic ceiling rose, threaded M6 rod, M6 short bracket /
Set per fissaggio a sospensione con tige 1m.
Staffa per fissaggio a soffitto, rosone in plastica, barra filettata M6, staffa corta M6

Code

0.02488.00

Finishes

10
21

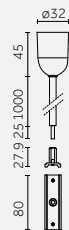

Description

Suspension kit with 1m tige.
Ceiling bracket, plastic ceiling rose, threaded M6 rod, M6 long bracket /
Set per fissaggio a sospensione con tige 1m.
Staffa per fissaggio a soffitto, rosone in plastica, barra filettata M6, staffa lunga M6

Code

0.02520.00

Finishes

10
21

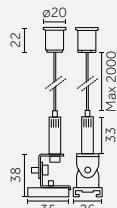
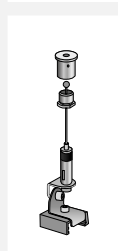

Description

Suspension kit with 2m long wire and counter-balance system /
Set sospensione con cavo da 2m e sistema di contro-bilanciamento

Code

0.02473.00

Finishes

10
21

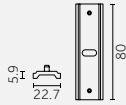
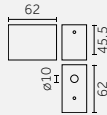

**Description**Short bracket for suspension/
Staffa corta per sospensione**Code**0.02479.0000**Description**Long bracket for suspension/
Staffa lunga per sospensione**Code**0.02482.0000**Description**Canopy surface kit for suspended track feeding.
Rose, ceiling bracket, 4-pole terminal block and gasket for cable passage/
Set basetta a superficie per alimentazione binario a sospensione.
Rosone, staffa per fissaggio a soffitto, morsettiera 4 poli e guarnizione per il passaggio del cavo**Code**0.02480.00**Finishes**

12	
31	

Electrical Devices

Track 48V - Remote driver

Driver

50W POWER LED									
Type	Code	W	Size (mm)	Tech. info	Vdc	Connectable fixtures	Max.distance	Cable section	
On/Off	0.31655.0000	50		220-240V / 50/60Hz	48Vdc	Max: 45 W	See chart here below	2.5 mm ²	
70W POWER LED									
On/Off	0.31656.0000	70		220-240V / 50/60Hz	48Vdc	Max: 63 W	See chart here below	2.5 mm ²	
150W POWER LED									
On/Off	0.31650.0000	150		220-240V / 50/60Hz	48Vdc	Max: 140 W	See chart here below	2.5 mm ²	
200W POWER LED									
On/Off	0.31657.0000*	200	—	—	48Vdc	—	See chart here below	2.5 mm ²	

*On request/Sur richiesta

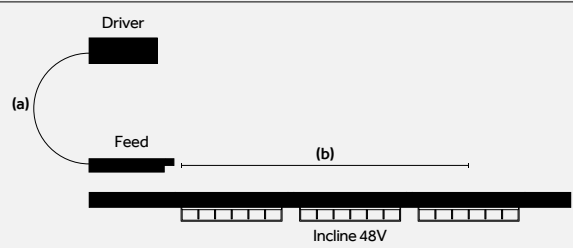

Driver	(a)	5 m	10m	20 m	30 m
50 W	(b)	55 m	50 m	40 m	30 m
70 W	(b)	35 m	30 m	20 m	10 m
150 W	(b)	20 m	15 m	5 m	-
200 W	(b)	15 m	10 m	-	-



(a) Distance Driver / Feed Unit
(b) Distance Feed Unit / Incline 48V

Track 48V - In-Track driver (for surface track)

In-Track Driver (for Standard surface track)

100W POWER LED									
Type	Code	W	Size (mm)	Tech. info	Vdc	Connectable fixtures	Cable length:	Cable section	
On/Off	0.30550.0000	100		220-240V / 50/60Hz	48Vdc	Max: 90 W	2.80 m	2.5 mm ²	
100W POWER LED									
DALI	D.30550.0000	100		220-240V / 50/60Hz	48Vdc	Max: 90 W	2.80 m	2.5 mm ²	







In-Track Driver (for Deep surface track)

250W POWER LED									
Type	Code	W	Size (mm)	Tech. info	Vdc	Connectable fixtures	Cable length:	Cable section	
On/Off	0.30551.0000	250		220-240V / 50/60Hz	48Vdc	Max: 240 W	2.80 m	2.5 mm ²	
250W POWER LED									
DALI	D.30551.0000	250		220-240V / 50/60Hz	48V	Max: 240 W	2.80 m	2.5 mm ²	

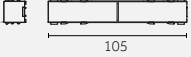
Electromechanical connections

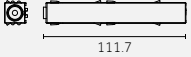
Electromechanical connections/ Conessioni elettromeccaniche

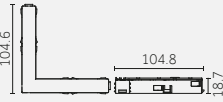

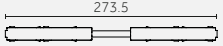

		Description Straight connector/ Giunto passante	Code 0.02486.00	Finishes 10 <input type="checkbox"/> 21 <input type="checkbox"/>
		Description End feed/ Testata di alimentazione	Code 0.02485.00	Finishes 10 <input type="checkbox"/> 21 <input type="checkbox"/>
		Description Feeding connector for 90° corner/ Giunto di alimentazione per angolo 90°	Code 0.02484.00	Finishes 10 <input type="checkbox"/> 21 <input type="checkbox"/>
		Description Flexible connector for 90° corner/ Giunto flessibile per angolo 90°	Code 0.02404.00	Finishes 10 <input type="checkbox"/> 21 <input type="checkbox"/>

Control systems

Track 48V - Casambi Bluetooth

Control device

		Description Wireless control device for 48V track*/ Dispositivo di controllo wireless per binario 48V*	Vdc 48Vdc	Code H.26104.00	Finishes 10 <input type="checkbox"/> 21 <input type="checkbox"/>
---	---	---	---------------------	---------------------------	---

^{EN} *To discover more, check out our Bluetooth control brochure.

^{IT} *Per saperne di più, consultate la nostra brochure sul controllo Bluetooth

Are you work
high voltage
Discover Incl

Working with
track?
Incline 220V

^{EN} Incline 220V has been designed to bring you a miniaturized yet high performing, integrated track lighting solution. The unique micro fixture is completely integrated inside the 14 mm aperture of the 3-circuit track. Available in Dark Performance, Opal and Wall washer versions.

^{IT} Incline 220V è stato progettato per offrire una soluzione di illuminazione miniaturizzata ma ad alte prestazioni e perfettamente integrata nei binari standard. Grazie alle sue dimensioni ridotte, Incline scompare dentro l'apertura di 14 mm dei binari a 3 circuiti. Disponibile nelle versioni Dark Performance, Opal e Wall Washer.

Incline 220 Dark Performance

Incline 220V Opal



^{EN} Discover Incline 220V on reggiani.net

^{IT} Scopri Incline 220V su reggiani.net

Versions:

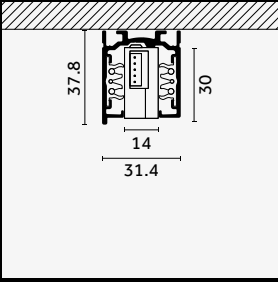

Incline Opal (Flush)

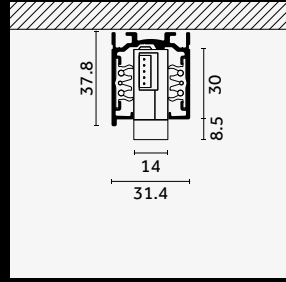

Incline Opal (Drop)

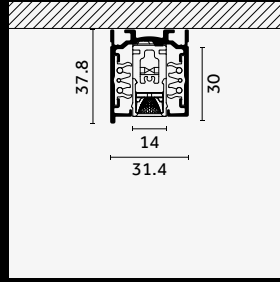

Incline Dark Performance

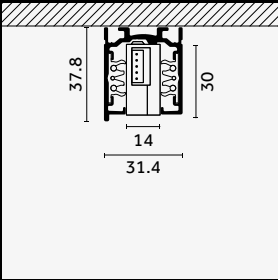

Incline Wall Washer (Flush)

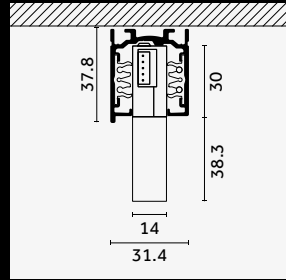

Incline Wall Washer (Drop)

Coming soon:

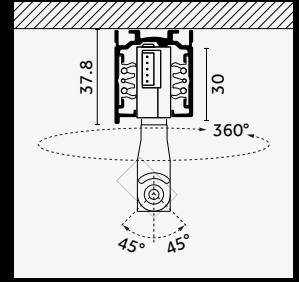

Incline Dark Performance Adjustable

Incline 48V

Incline 220V Dark Performance Adjustable
(Coming soon)

Incline 220V Wall Washer

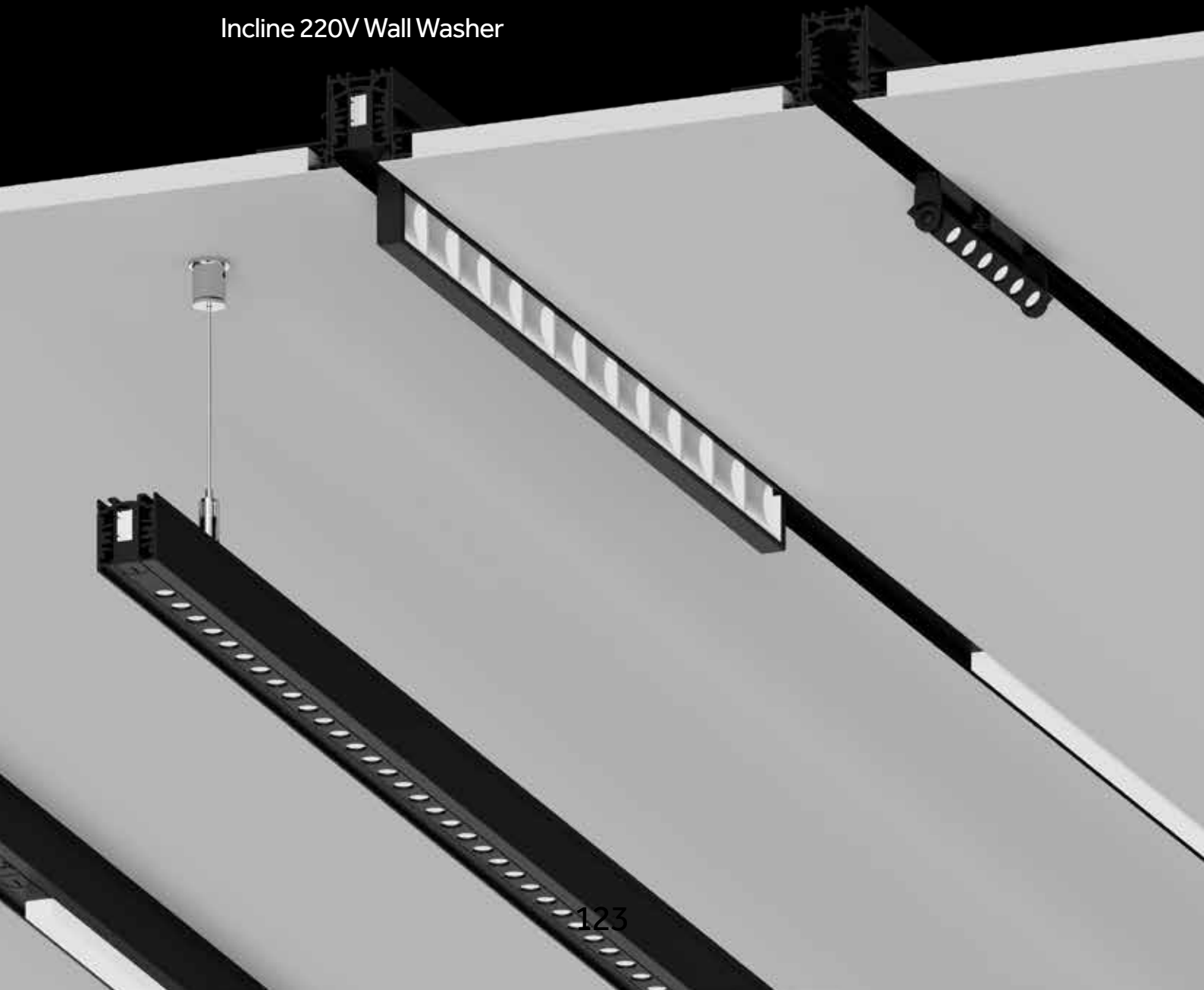

Reggiani

©
2024
Reggiani Lighting Srl
All rights reserved

Art direction
Reggiani

Graphic design
Reggiani

Pictures
Reggiani
Lens Visual

^{EN} Reggiani Lighting Srl reserves the right to make technical, design and size changes at any time, without prior notice. Total or partial reproduction of this document is prohibited. Luminaire sizes are given in millimetres. All technical and design innovations are patented. Watts and lumens refer to the nominal values of the LED source; for photometric data and lumen output of the luminaires, visit www.reggiani.net

^{IT} Reggiani Lighting Srl si riserva la facoltà di effettuare in qualsiasi momento senza preavviso, variazioni tecniche, formali e dimensionali. Sono vietate le riproduzioni anche parziali del presente documento. Le dimensioni degli apparecchi sono espresse in millimetri. Tutte le innovazioni tecniche e formali sono coperte da brevetto. Watt e lumen fanno riferimento ai valori nominali della sorgente LED, per i dati fotometrici e il lumen output degli apparecchi visitare www.reggiani.net

HEADQUARTERS
Reggiani Lighting Srl

Viale Monza 16
20845 Sovico (MB), Italy
T. (+39) 039 20711
contact@reggiani.net



Part of
NEMO Group

